



(19) **United States**

(12) **Patent Application Publication**  
**Ludwig**

(10) **Pub. No.: US 2014/0104219 A1**

(43) **Pub. Date: Apr. 17, 2014**

(54) **SENSOR ARRAY TOUCHSCREEN  
RECOGNIZING TOUCH GESTURES**

**Publication Classification**

(71) Applicant: **Lester F. Ludwig**, San Antonio, TX  
(US)

(51) **Int. Cl.**  
**G06F 3/01** (2006.01)  
**G06F 3/041** (2006.01)

(72) Inventor: **Lester F. Ludwig**, San Antonio, TX  
(US)

(52) **U.S. Cl.**  
CPC ..... **G06F 3/017** (2013.01); **G06F 3/0412**  
(2013.01)  
USPC ..... **345/173**

(21) Appl. No.: **14/141,257**

(57) **ABSTRACT**

(22) Filed: **Dec. 26, 2013**

Touchscreen user interfaces for controlling software applications, computers, devices, machinery, and process environments with touch gestures. Such user interfaces can be manipulated by users and provide a wide range of uses with computer applications, assistance to the disabled, and control of electronic devices, machines, and processes. Enhancements can include velocity and pressure sensing capabilities. The touchscreen can be realized with a transparent touch sensor array positioned over a visual display. Dynamically assigned labels can be provided by the visual display. Multi-touch capabilities can be included that are responsive to additional contact, for example by other parts of a user hand. Displayed visual content, including visual content selection, motion, and sizing, can be controlled by finger flicks and other touch gestures. Finger movement trajectories can be tracked, and pluralities of control parameters can be associated with each gesture.

**Related U.S. Application Data**

(60) Continuation of application No. 11/761,978, filed on Jun. 12, 2007, which is a continuation of application No. 09/812,400, filed on Mar. 19, 2001, now Pat. No. 7,786,370, which is a division of application No. 09/313,533, filed on May 15, 1999, now Pat. No. 6,610,917.

(60) Provisional application No. 60/085,713, filed on May 15, 1998.

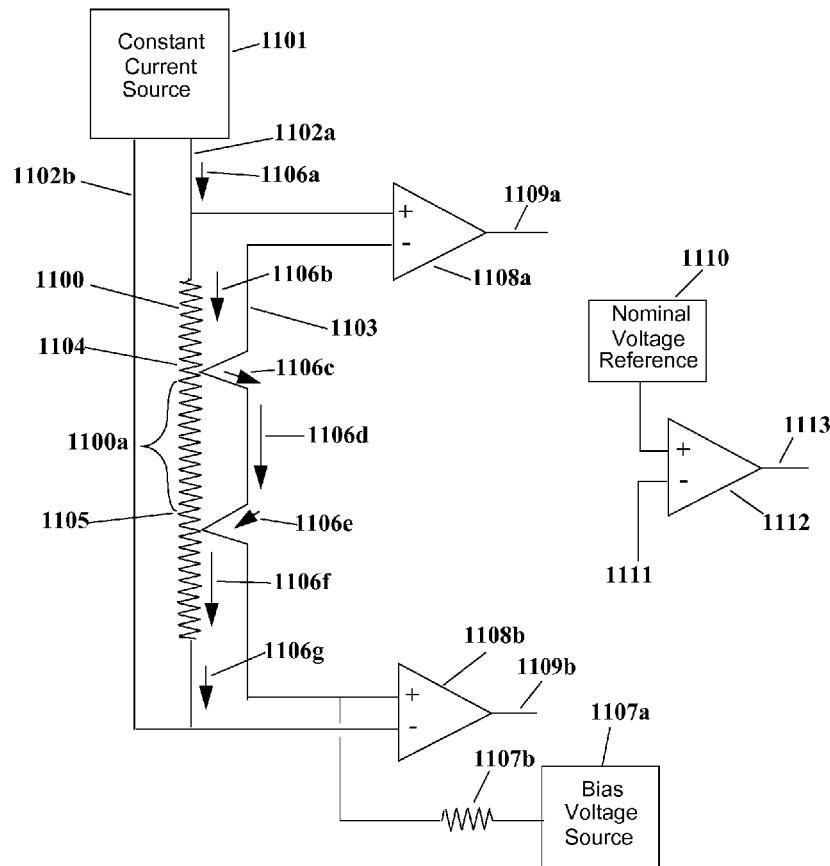

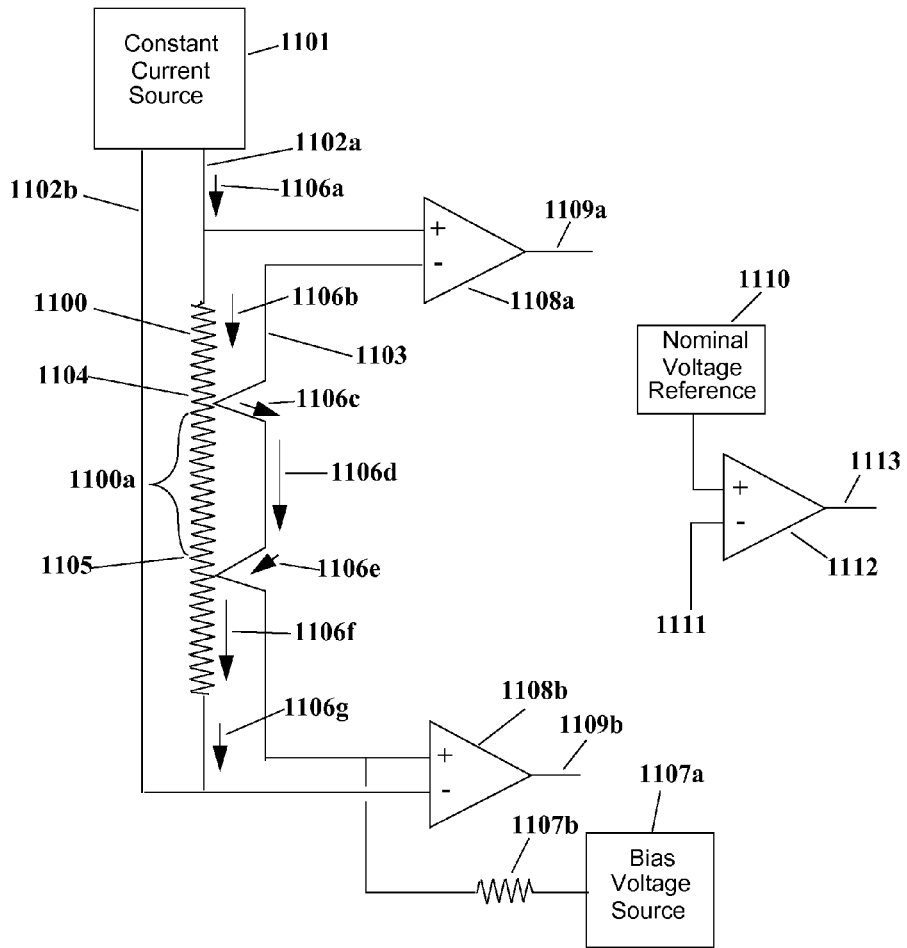

Figure 1

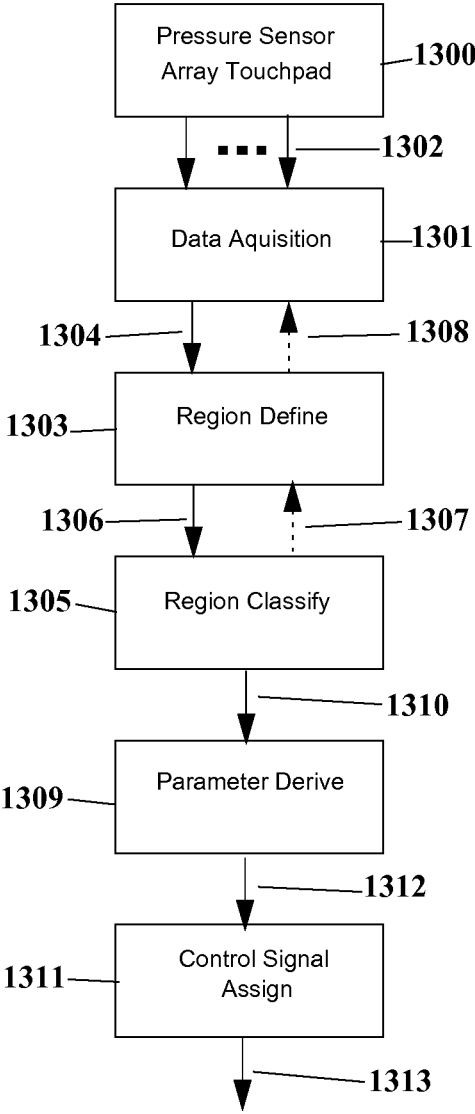

Figure 2

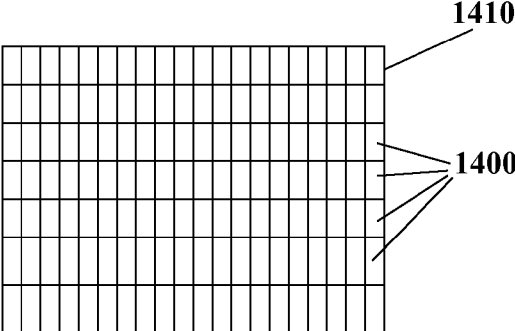

Figure 3

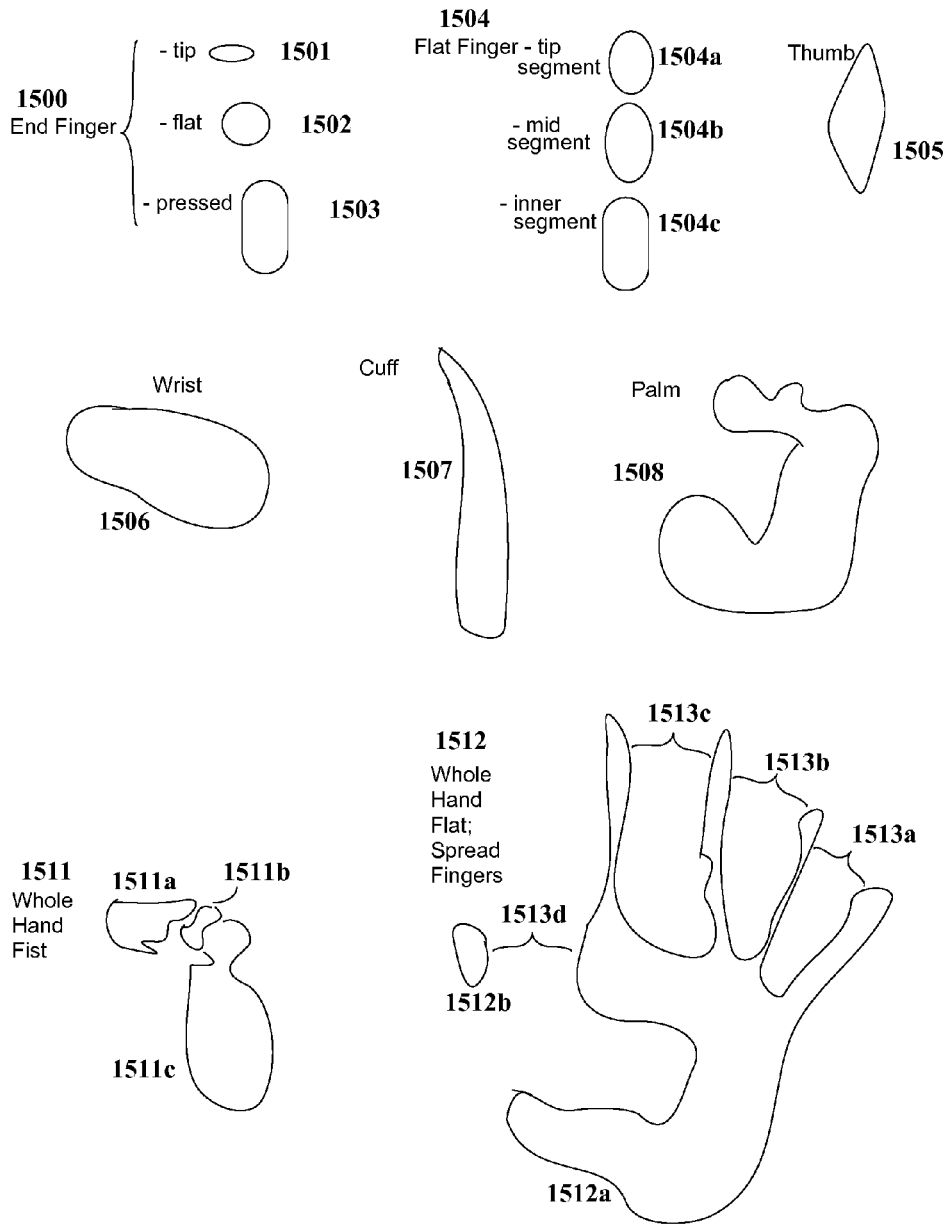

Figure 4

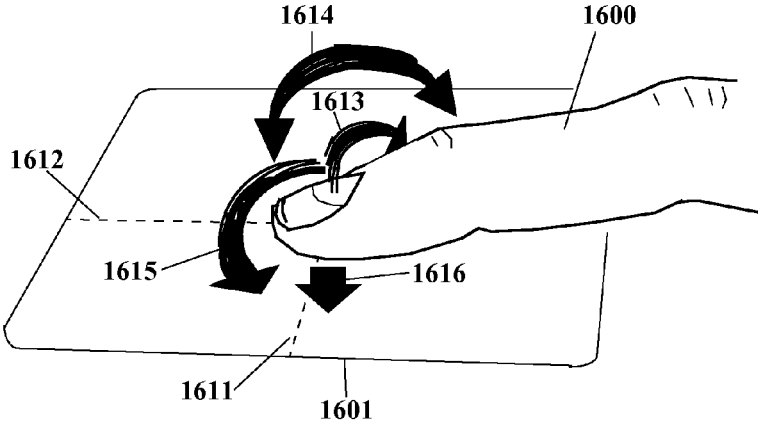

Figure 5

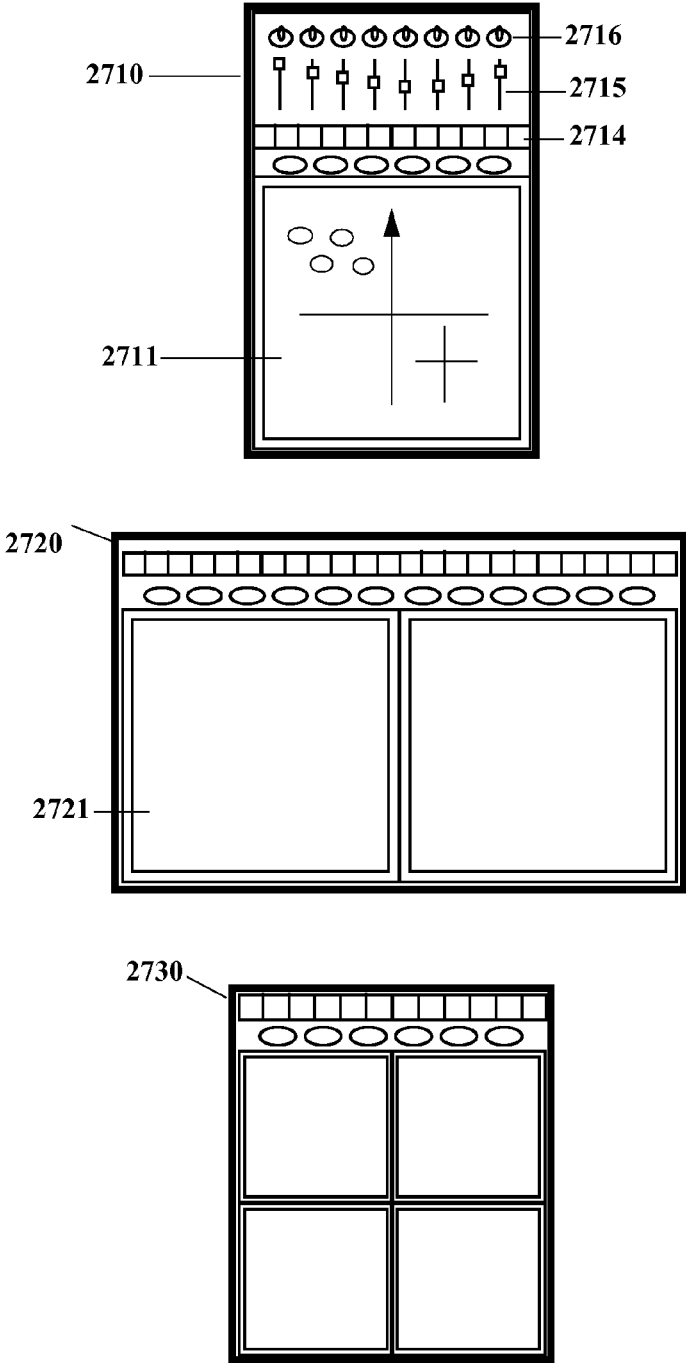

Figure 6

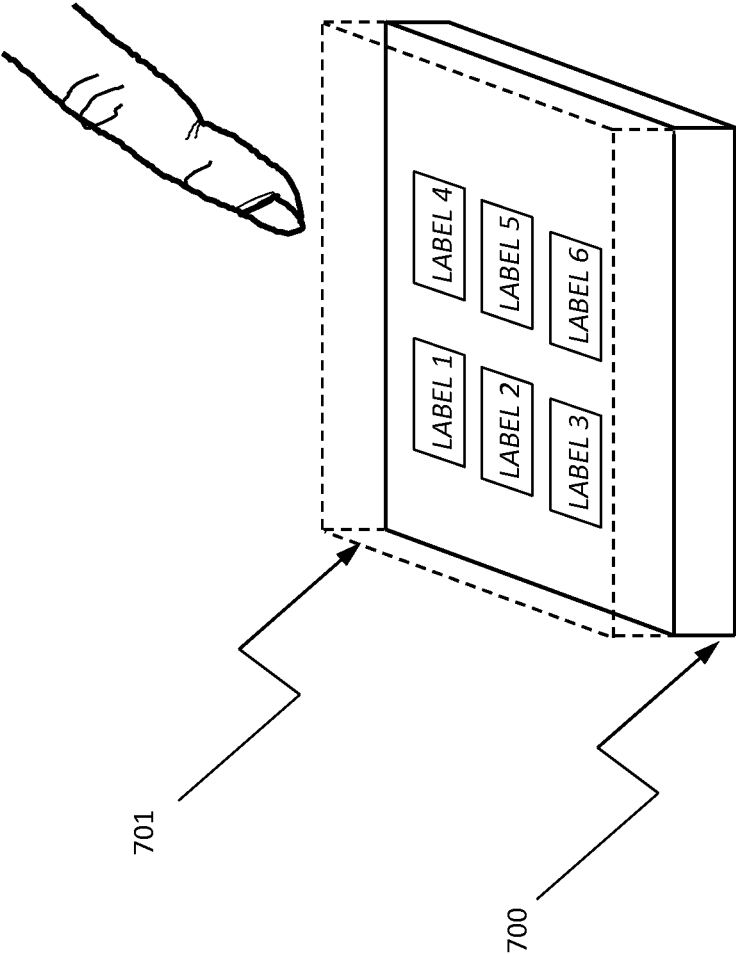

Figure 7



## SENSOR ARRAY TOUCHSCREEN RECOGNIZING TOUCH GESTURES

### CROSS REFERENCE TO RELATED APPLICATIONS

**[0001]** This application is a continuation of U.S. application Ser. No. 11/761,978, filed Jun. 12, 2007, which is a continuation of U.S. application Ser. No. 09/812,400, filed Mar. 19, 2001, now U.S. Pat. No. 7,786,370, issued Aug. 31, 2010, which is a division of U.S. application Ser. No. 09/313,533, filed May 15, 1999, now U.S. Pat. No. 6,610,917, issued Aug. 26, 2003, which claims benefit of priority of U.S. Provisional Application No. 60/085,713, filed May 15, 1998.

### FIELD OF INVENTION

**[0002]** The present invention relates generally to a control system, and in particular, to a tactile input controller for controlling an associated system.

### SUMMARY OF THE INVENTION

**[0003]** Touchpad user interfaces for controlling external systems such as computers, machinery, and process environments via at least three independent control signals. The touchpad may be operated by hand, other parts of the body, or inanimate objects. Such an interface affords a wide range of uses in computer applications, machine and process control, and assistance to the disabled. In one embodiment simple contact position-sensing touchpads, producing control signals responsive to a contact region, are enhanced to provide several independent control signals. Enhancements may include velocity sensors, pressure sensors, and electronic configurations measuring contact region widths. Touchscreens positioned over visual displays may be adapted. According to other aspects pressure-sensor array touchpads are combined with image processing to responsively calculate parameters from contact regions. Six independent control parameters can be derived from each region of contact. These may be easily manipulated by a user. In one implementation, smaller pressure-sensor arrays are combined with data acquisition and processing into a chip that can be tiled in an array.

### DESCRIPTION OF THE DRAWINGS

**[0004]** The above and other aspects, features and advantages of the present invention will become more apparent upon consideration of the following description of preferred embodiments taken in conjunction with the accompanying drawing figures, wherein:

**[0005]** FIG. 1 shows an example of how two independent contact points can be independently discerned, or the dimensional-width of a single contact point can be discerned, for a resistance null/contact controller with a single conductive contact plate or wire and one or more resistive elements whose resistance per unit length is a fixed constant through each resistive element;

**[0006]** FIG. 2 shows how a pressure-sensor array touch-pad can be combined with image processing to assign parameterized interpretations to measured pressure gradients and output those parameters as control signals;

**[0007]** FIG. 3 illustrates the positioning and networking of pressure sensing and processing “mini-array” chips in larger contiguous structures;

**[0008]** FIG. 4 illustrates the pressure profiles for a number of example hand contacts with a pressure-sensor array;

**[0009]** FIG. 5 illustrates how six degrees of freedom can be recovered from the contact of a single finger; and

**[0010]** FIG. 6 illustrates examples of single, double, and quadruple touch-pad instruments with pads of various sizes and supplemental instrument elements.

**[0011]** FIG. 7 illustrates an example implementation involving dynamically assigned labels.

### DETAILED DESCRIPTION

#### Overview

**[0012]** Described herein are two kinds of novel touch-pads. Null/contact touchpads are contact-position sensing devices that normally are in a null state unless touched and produce a control signal when touched whose signal value corresponds to typically one unique position on the touch-pad. A first enhancement is the addition of velocity and/or pressure sensing. A second enhancement is the ability to either discern each dimensional-width of a single contact area or, alternatively, independently discern two independent contact points in certain types of null/contact controllers. A third possible enhancement is that of employing a touch-screen instance of null/contact touch pad and positioning it over a video display.

**[0013]** The invention also provides for a pressure-sensor array touch-pad. A pressure-sensor array touch-pad of appropriate sensitivity range, appropriate “pixel” resolution, and appropriate physical size is capable of measuring pressure gradients of many parts of the human hand or foot simultaneously. A pressure-sensor array touch-pad can be combined with image processing to assign parameterized interpretations to measured pressure gradients and output those parameters as control signals. The pressure-sensor “pixels” of a pressure-sensor array are interfaced to a data acquisition stage; the data acquisition state looks for sensor pixel pressure measurement values that exceed a low-level noise-rejection/deformity-reject threshold; contiguous regions of sufficiently high pressure values are defined; the full collection of region boundaries are subjected to classification tests; various parameters are derived from each independent region; and these parameters are assigned to the role of specific control signals which are then output to a signal routing, processing, and synthesis entity.

**[0014]** It is possible to derive a very large number of independent control parameters which are easily manipulated by the operating user. For example, six degrees of freedom can be recovered from the contact of a single finger. A whole hand posture can yield 17 instantaneously and simultaneously measurable parameters which are independently adjustable per hand. The recognized existence and/or derived parameters from postures and gestures may be assigned to specific outgoing control signal formats and ranges. The hand is used throughout as an example, but it is understood that the foot or even other body regions, animal regions, objects, or physical phenomena can replace the role of the hand.

**[0015]** It will be evident to one of ordinary skill in the art that it is advantageous to have large numbers of instantaneously and simultaneously measurable parameters which are independently adjustable. For instance, a symbol in a 2-D CAD drawing can be richly interactively selected and installed or edited in moments as opposed to tens to hundreds of seconds as is required by mouse manipulation of parameters one or two at a time and the necessary mode-changes needed to change the mouse action interpretation. As a result, said touch-pad has applications in computer workstation con-

trol, general real-time machine control, computer data entry, and computer simulation environments.

**[0016]** Various hardware implementations are possible. A particularly advantageous implementation would be to implement a small pressure-sensor array together with data acquisition and a small processor into a single chip package that can be laid as tiles in a larger array.

#### Null/Contact Touch-Pads

**[0017]** Distinguished from panel controls and sensors are what will be termed null/contact touch-pads. This is a class of contact-position sensing devices that normally are in a null state unless touched and produce a control signal when touched whose signal value corresponds to typically one unique position on the touch-pad. Internal position sensing mechanisms may be resistive, capacitive, optical, standing wave, etc. Examples of these devices include one-dimensional-sensing ribbon controllers found on early music synthesizers, two-dimensional-sensing pads such as the early Kawala pad and more modern mini-pads found on some lap-top computers, and two-dimensional-sensing see-through touch—screens often employed in public computer kiosks.

**[0018]** The null condition, when the pad is untouched, requires and/or provides the opportunity for special handling. Some example ways to handle the untouched condition include:

**[0019]** sample-hold (hold values issued last time sensor was touched, as does a joystick)

**[0020]** bias **1107a**, **1107b** (issue maximal-range value, minimal-range value, mid-range value, or other value)

**[0021]** touch-detect on another channel (i.e., a separate out-of-band “gate” channel).

**[0022]** Additional enhancements can be added to the adaptation of null/contact touch-pad controllers as instrument elements. A first enhancement is the addition of velocity and/or pressure sensing. This can be done via global impact and/or pressure-sensors. An extreme of this is implementation of the null/contact touch-pad controller as a pressure-sensor array; this special case and its many possibilities are described later.

**[0023]** A second enhancement is the ability to either discern each dimensional-width of a single contact area or, alternatively, independently discern two independent contact points in certain types of null/contact controllers. FIG. 1 shows an example of how two independent contact points can be independently discerned, or the dimensional-width of a single contact point can be discerned, for a resistance null/contact controller with a single conductive contact plate (as with the Kawala pad product) or wire (as in a some types of ribbon controller products) and one or more resistive elements **1100** whose resistance per unit length is a fixed constant through each resistive element. It is understood that a one-dimensional null/contact touch-pad typically has one such resistive element while a two-dimensional null/contact touch-pad typically has two such resistive elements that operate independently in each direction.

**[0024]** Referring to FIG. 1, a constant current source **1101** can be applied to the resistive element as a whole **1102a-1102b**, developing a fixed voltage across the entire resistive element **1100**. When any portion of the resistive element is contacted by either a non-trivial contiguous width and/or multiple points of contact **1104-1105**, part of the resistive element is shorted out **1100a**, thus reducing the overall width-to-end resistance of the resistance element. Because of the

constant current source **1101**, the voltage developed across the entire resistive element **1102a-1102b** drops by an amount equal to the portion of the resistance that is shorted out.

**[0025]** The value of the voltage drop then equals a value in proportion to the distance separating the extremes of the wide and/or multiple contact points **1104-1105**. By subtracting **1111**, **1112**, **1113** the actual voltage across the entire resistive element from the value this voltage is normally **1110**, a control voltage proportional to distance separating the extremes of the wide and/or multiple contact points **1104-1105** is generated. Simultaneously, the voltage difference between that of the contact plate/wire **1103** and that of the end of the resistive element closest to an external contact point **1102a** or **1102b** is still proportional to the distance from said end to said external contact point. Using at most simple op-amp summing and/or differential amplifiers **1108a**, **1108b**, **1112**, a number of potential control voltages can be derived; for example one or more of these continuously-valued signals:

**[0026]** value of distance difference between external contact points (or “width”; as described above via constant current source, nominal reference voltage, and differential amplifier **1113**)

**[0027]** center of a non-trivial-width region (obtained by simple averaging, i.e., sum with gain of ½)

**[0028]** value of distance difference **1109a** between one end of the resistive element and the closest external contact point (simple differential amplifier)

**[0029]** value of distance difference between the other end of the resistive element and the other external contact point (sum above voltage with “width” voltage with appropriate sign) **1109b**.

**[0030]** Further, through use of simple threshold comparators, specific thresholds of shorted resistive element can be deemed to be, for example, any of a single point contact, a recognized contact region width, two points of contact, etc., producing corresponding discrete-valued control signals. The detection of a width can be treated as a contact event for a second parameter analogous to the single contact detection event described at the beginning. Some example usages of these various continuous and discrete signals are:

**[0031]** existence of widths or multiple contact points may be used to trigger events or timbre changes

**[0032]** degree of widths may be used to control degrees of modulation or timbre changes

**[0033]** independent measurement of each external contact point from the same end of the resistive element can be used to independently control two parameters. In the simplest form, one parameter is always larger than another; in more complex implementations, the trajectories of each contact point can be tracked (using a differentiator and controlled parameter assignment switch); as long as they never simultaneously touch, either parameter can vary and be larger or smaller than the other.

**[0034]** It is understood that analogous approaches may be applied to other null/contact touchpad technologies such as capacitive or optical.

**[0035]** A third possible enhancement is that of employing a touch-screen instance of null/contact touch-pad and positioning it over a video display. The video display could for example provide dynamically assigned labels, abstract spatial cues, spatial gradients, line-of-site cues for fixed or motor-

controlled lighting, etc. which would be valuable for use in conjunction with the adapted null/contact touch-pad controller.

**[0036]** These various methods of adapted null/contact touch-pad elements can be used stand-alone or arranged in arrays. In addition, they can be used as a component or addendum to instruments featuring other types of instrument elements.

#### Pressure-Sensor Array Touch-Pads

**[0037]** The invention provides for use of a pressure-sensor array arranged as a touch-pad together with associated image processing. As with the null/contact controller, these pressure-sensor array touch-pads may be used stand-alone or organized into an array of such pads.

**[0038]** It is noted that the inventor's original vision of the below described pressure-sensor array touch-pad was for applications not only in music but also for computer data entry, computer simulation environments, and real-time machine control, applications to which the below described pressure-sensor array touch-pad clearly can also apply.

**[0039]** A pressure-sensor array touch-pad of appropriate sensitivity range, appropriate "pixel" resolution, and appropriate physical size is capable of measuring pressure gradients of many parts of the flexibly-rich human hand or foot simultaneously. FIG. 2 shows how a pressure sensor array touch-pad can be combined with image processing to assign parameterized interpretations to measured pressure gradients and output those parameters as control signals.

**[0040]** The pressure-sensor "pixels" of a pressure-sensor array touch-pad **1300** are interfaced to a data acquisition stage **1301**. The interfacing method may be fully parallel but in practice may be advantageously scanned at a sufficiently high rate to give good dynamic response to rapidly changing human touch gestures. To avoid the need for a buffer amplifier for each pressure-sensor pixel, electrical design may carefully balance parasitic capacitance of the scanned array with the electrical characteristics of the sensors and the scan rates; electrical scanning frequencies can be reduced by partitioning the entire array into distinct parts that are scanned in parallel so as to increase the tolerance for address settling times and other limiting processes.

**[0041]** Alternatively, the pressure-sensor array **1300** may be fabricated in such a way that buffer amplifier arrays can be inexpensively attached to the sensor array **1300**, or the sensors may be such that each contains its own buffer amplifier; under these conditions, design restrictions on scanning can be relaxed and operate at higher speeds. Although the pressure sensors may be likely analog in nature, a further enhancement would be to use digital-output pressure-sensor elements or sub-arrays.

**[0042]** The data acquisition stage **1301** looks for sensor pixel pressure measurement values that exceed a low-level noise-rejection/deformity-rejection threshold. The sufficiently high pressure value of each such sensor pixel is noted along with the relative physical location of that pixel (known via the pixel address). This noted information may be stored "raw" for later processing and/or may be subjected to simple boundary tests and then folded into appropriate running calculations as will be described below. In general, the pressure values and addresses of sufficiently high pressure value pixels are presented to a sequence of processing functions which may be performed on the noted information:

**[0043]** contiguous regions of sufficiently high pressure values are defined (a number of simple run-time adjacency tests can be used; many are known—see for example [Ronse; Viberg; Shaperio; Hara])

**[0044]** the full collection of region boundaries are subjected to classification tests; in cases a given contiguous region may be split into a plurality of tangent or co-bordered independently recognized regions

**[0045]** various parameters are derived from each independent region, for example geometric center, center of pressure, average pressure, total size, angle-of-rotation-from reference for non-round regions, second-order and higher-order geometric moments, second-order and higher-order pressure moments, etc.

**[0046]** assignment of these parameters to the role of specific control signals (note events, control parameters, etc.) which are then output to a signal routing, processing, and synthesis entity; for example, this may be done in the form of MIDI messages.

**[0047]** Because of the number of processes involved in such a pipeline, it is advantageous to follow a data acquisition stage **1301** with one or more additional processing stages **1303**, **1305**, **1309**, and **1311**. Of the four example processing functions just listed, the first three fall in the character of image processing. It is also possible to do a considerable amount of the image processing steps actually within the data acquisition step, namely any of simple adjacency tests and folding selected address and pressure measurement information into running sums or other running pre-calculations later used to derive aforementioned parameters. The latter method can be greatly advantageous as it can significantly collapse the amount of data to be stored.

**[0048]** Regardless of whether portions of the image processing are done within or beyond the data acquisition stage, there are various hardware implementations possible. One hardware approach would involve very simple front-end scanned data acquisition hardware and a single high-throughput microprocessor/signal-processor chip. Alternatively, an expanded data acquisition stage may be implemented in high-performance dedicated function hardware and this would be connected to a lower performance processor chip. A third, particularly advantageous implementation would be to implement a small pressure-sensor array together with data acquisition and a small processor into a single low-profile chip package that can be laid as tiles in a nearly seamless larger array. In such an implementation all image processing could in fact be done via straightforward partitions into message-passing distributed algorithms.

**[0049]** One or more individual chips could direct output parameter streams to an output processor which would organize and/or assign parameters to output control channels, perhaps in a programmable manner under selectable stored program control. A tiled macro array of such "sensor mini-array" chips could be networked by a tapped passive bus, one- or two-dimensional mode active bus daisy-chain, a potentially expandable star-wired centralized message passing chip or subsystem, or other means.

**[0050]** Creating a large surface from such "tile chips" will aid in the serviceability of the surface. Since these chips can be used as tiles to build a variety of shapes, it is therefore possible to leverage a significant manufacturing economy-of-scale so as to minimize cost and justify more extensive feature development. Advanced seating and connector technologies, as used in laptops and other high-performance miniature con-

sumer electronics, can be used to minimize the separation between adjacent chip “tiles” and resultant irregularities in the tiled-surface smoothness. A tiled implementation may also include a thin rugged flexible protective film that separates the sensor chips from the outside world. FIG. 3 illustrates the positioning and networking of pressure sensing and processing “mini-array” chips 1400 in larger contiguous structures 1410.

**[0051]** With the perfection of a translucent pressure-sensor array, it further becomes possible for translucent pressure-sensor arrays to be laid atop aligned visual displays such as LCDs, florescent, plasma, CRTs, etc. as was discussed above for null/contact touch-pads. The displays can be used to label areas of the sensor array, illustrate gradients, etc. FIG. 7 illustrates an example implementation involving dynamically assigned labels on a video display 700 for use in conjunction with a transparent touch-screen 701. Note that in the “tile chip” implementation, monochrome or color display areas may indeed be built into each chip.

**[0052]** Returning now to the concept of a pressure-sensor array touch-pad large enough for hand-operation: examples of hand contact that may be recognized, example methods for how these may be translated into control parameters, and examples of how these all may be used are now described. In the below the hand is used throughout as an example, but it is understood that the foot or even other body regions, animal regions, objects, or physical phenomena can replace the role of the hand in these illustrative examples.

**[0053]** FIG. 4 illustrates the pressure profiles for a number of example hand contacts with a pressure-sensor array. In the case 1500 of a finger’s end, pressure on the touch-pad pressure-sensor array can be limited to the finger tip, resulting in a spatial pressure distribution profile 1501; this shape does not change much as a function of pressure. Alternatively, the finger can contact the pad with its flat region, resulting in light pressure profiles 1502 which are smaller in size than heavier pressure profiles 1503. In the case 1504 where the entire finger touches the pad, a three-segment pattern (1504a, 1504b, 1504c) will result under many conditions; under light pressure a two segment pattern (1504b or 1504c missing) could result. In all but the lightest pressures the thumb makes a somewhat discernible shape 1505 as do the wrist 1506, cuff 1507, and palm 1508; at light pressures these patterns thin and can also break into disconnected regions. Whole hand patterns such as the first 1511 and flat hand 1512 have more complex shapes. In the case of the first 1511, a degree of curl can be discerned from the relative geometry and separation of sub-regions (here depicted, as an example, as 1511a, 1511b, and 1511c). In the case of the whole flat hand 1512, there can be two or more sub-regions which may be in fact joined (as within 1512a) and/or disconnected (as an example, as 1512a and 1512b are); the whole hand also affords individual measurement of separation “angles” among the digits and thumb (1513a, 1513b, 1513c, 1513d) which can easily be varied by the user.

**[0054]** Relatively simple pattern recognition software can be used to discern these and other hand contact patterns which will be termed “postures.” The pattern recognition working together with simple image processing may, further, derive a very large number of independent control parameters which are easily manipulated by the operating user. In many cases it may be advantageous to train a system to the particulars of a specific person’s hand(s) and/or specific postures. In other situations the system may be designed to be fully adaptive and

adjust to a person’s hand automatically. In practice, for the widest range of control and accuracy, both training and ongoing adaptation may be useful. Further, the recognized postures described thus far may be combined in sequence with specific dynamic variations among them (such as a finger flick, double-tap, etc.) and as such may be also recognized and thus treated as an additional type of recognized pattern; such sequential dynamics among postures will be termed “gestures.”

**[0055]** The admission of gestures further allows for the derivation of additional patterns such as the degree or rate of variation within one or more of the gesture dynamics. Finally, the recognized existence and/or derived parameters from postures and gestures may be assigned to specific outgoing control signal formats and ranges. Any training information and/or control signal assignment information may be stored and recalled for one or more players via stored program control.

**[0056]** For each recognized pattern, the amount of information that can be derived as parameters is in general very high. For the human hand or foot, there are, typically, artifacts such as shape variation due to elastic tissue deformation that permit recovery of up to all six degrees of freedom allowed in an object’s orientation in 3-space.

**[0057]** FIG. 5 illustrates how six degrees of freedom can be recovered from the contact of a single finger. In the drawing, the finger 1600 makes contact with the touch-pad 1601 with its end segment at a point on the touch-pad surface determined by coordinates 1611 and 1612 (these would be, for example, left/right for 1611 and forward/backward for 1612). Fixing this point of contact, the finger 1600 is also capable of rotational twisting along its length 1613 as well as rocking back and forth 1614. The entire finger can also be pivoted with motion 1615 about the contact point defined by coordinates 1611 and 1612. These are all clearly independently controlled actions, and yet it is still possible in any configuration of these thus far five degrees of freedom, to vary the overall pressure 1616 applied to the contact point. Simple practice, if it is even needed, allows the latter overall pressure 1616 to be independently fixed or varied by the human operator as other parameters are adjusted.

**[0058]** In general other and more complex hand contacts, such as use of two fingers, the whole hand, etc. forfeit some of these example degrees of freedom but often introduce others. For example, in the quite constrained case of a whole hand posture, the fingers and thumb can exert pressure independently (5 parameters), the finger and thumb separation angles can be varied (4 parameters), the finger ends 1504a can exert pressure independently from the middle 1504b and inner 1504c segments (4 parameters), the palm can independently vary its applied pressure (1 parameter) while independently tilting/rocking in two directions (2 parameters) and the thumb can curl (1 parameter), yielding 17 instantaneously and simultaneously measurable parameters which are independently adjustable per hand. Complex contact postures may also be viewed as, or decomposed into, component sub-postures (for example here, as flat-finger contact, palm contact, and thumb contact) which would then derive parameters from each posture independently. For such complex contact postures, recognition as a larger compound posture which may then be decomposed allows for the opportunity to decouple and/or renormalize the parameter extraction in recognition of the special affairs associated with and constraints imposed by specific complex contact postures.

**[0059]** It is noted that the derived parameters may be pre-processed for specific uses. One example of this would be the quantization of a parameter into two or more discrete steps; these could for example be sequentially interpreted as sequential notes of a scale or melody. Another example would be that of warping a parameter range as measured to one with a more musically expressive layout.

**[0060]** Next examples of the rich metaphorical aspects of interacting with the pressure sensor array touch-pad are illustrated. In many cases there may be one or more natural geometric metaphor(s) applicable, such as associating left-right position, left-right twisting, or left-right rotation with stereo panning, or in associating overall pressure with volume or spectral complexity. In more abstract cases, there may be pairs of parameters that go together—here, for example with a finger end, it may be natural to associate one parameter pair with (left/right and forward/backward) contact position and another parameter pair with (left/right and forward/backward) twisting/rocking. In this latter example there is available potential added structure in the metaphor by viewing the twisting/rocking plane as being superimposed over the position plane. The superposition aspect of the metaphor can be viewed as an index, or as an input-plane/output-plane distinction for a two-input/two-output transformation, or as two separated processes which may be caused to converge or morph according to additional overall pressure, or in conjunction with a dihedral angle of intersection between two independent processes, etc.

**[0061]** Next, examples of the rich syntactical aspects of interacting with the pressure-sensor array touch-pad are illustrated. Some instruments have particular hand postures naturally associated with their playing. It is natural then to recognize these classical hand-contact postures and derive control parameters that match and/or transcend how a classical player would use these hand positions to evoke and control sound from the instrument. Further, some postures could be recognized either in isolation or in gestural-context as being ones associated with (or assigned to) percussion effects while remaining postures may be associated with accompanying melodies or sound textures.

**[0062]** As an additional syntactic aspect, specific hand postures and/or gestures may be mapped to specific selected assignments of control signals in ways affiliated with specific purposes. For example, finger ends may be used for one collection of sound synthesis parameters, thumb for a second potentially partially overlapping collection of sound synthesis parameters, flat fingers for a third partially-overlapping collection, wrist for a fourth, and cuff for a fifth, and first for a sixth. In this case it may be natural to move the hand through certain connected sequences of motions; for example: little finger end, still in contact, dropping to flat-finger contact, then dropping to either palm directly or first to cuff and then to palm, then moving to wrist, all never breaking contact with the touch-pad. Such permissible sequences of postures that can be executed sequentially without breaking contact with the touch-pad will be termed “continuous grammars.”

**[0063]** Under these circumstances it is useful to set up parameter assignments, and potentially associated context-sensitive parameter renormalizations, that work in the context of selected (or all available) continuous grammars. For example, as the hand contact evolves as being recognized as one posture and then another, parameters may be smoothly handed-over in interpretation from one posture to another

without abrupt changes, while abandoned parameters either hold their last value or return to a default value (instantly or via a controlled envelope).

**[0064]** Now a number of example applications of the pressure-sensor array touchpad are provided. It is known to be possible and valuable to use the aforementioned pressure-sensor array touch-pad, implicitly containing its associated data acquisition, processing, and assignment elements, for many, many applications such as general machine control and computer workstation control. One example of machine control is in robotics: here a finger might be used to control a hazardous material robot hand as follows:

**[0065]** left/right position: left/right hand position

**[0066]** in/out position: in/out hand position

**[0067]** in/out rock: up/down hand position

**[0068]** rotation: hand grip approach angle

**[0069]** overall pressure: grip strength

**[0070]** left/right twist: gesture to lock or release current grip from pressure control

**[0071]** A computer workstation example may involve a graphical Computer-Aided Design application currently requiring intensive mouse manipulation of parameters one or two at a time:

**[0072]** left/right position: left/right position of a selected symbol in a 2-D CAD drawing

**[0073]** in/out position: up/down position of a selected symbol in 2-D CAD drawing

**[0074]** left/right twist: symbol selection—left/right motion through 2-D palette

**[0075]** in/out rock: symbol selection—up/down motion through 2-D palette

**[0076]** rotation: rotation of selected symbol in the drawing

**[0077]** overall pressure: sizing by steps

**[0078]** tap of additional finger: lock selection into drawing or unlock for changes

**[0079]** tap of thumb: undo

**[0080]** palm: toggle between add new object and select existing object

**[0081]** Clearly a symbol can be richly interactively selected and installed or edited in moments as opposed to tens to hundreds of seconds as is required by mouse manipulation of parameters one or two at a time and the necessary mode-changes needed to change the mouse action interpretation.

#### Touch-Pad Array

**[0082]** Touch-pad instrument elements, such as null/contact types and pressure-sensor array types described earlier, can be used in isolation or arrays to create electronic controller instruments. The touch-pad(s) may be advantageously supplemented with panel controls such as push buttons, sliders, knobs as well as impact sensors for velocity-controlled triggering of percussion or pitched note events. If one or more of the touch-pads is transparent (as in the case of a null/contact touch screen overlay) one or more video, graphics, or alphanumeric displays **2711** may be placed under a given pad or group of pads.

**[0083]** FIG. 6 illustrates examples of single **2710**, double **2720**, and quadruple **2730** touchpad instruments with pads of various sizes. A single touch-pad could serve as the central element of such an instrument, potentially supplemented with panel controls such as push buttons **2714**, sliders **2715**, knobs **2716** as well as impact sensors. In FIG. 6, a transparent pad superimposed over a video, graphics, or one or more alpha-

numeric displays is assumed, and specifically shown is a case of underlay graphics cues being displayed for the player. Two large sensors can be put side by side to serve as a general purpose left-hand/right-hand multi-parameter controller.

[0084] All publications and patent applications mentioned in this specification are herein incorporated by reference to the same extent as if each individual publication or patent application was specifically and individually indicated to be incorporated by reference. The invention now being fully described, it will be apparent to one of ordinary skill in the art that many changes and modifications can be made thereto without departing from its spirit or scope.

#### REFERENCES CITED

[0085] The following references are cited in this patent application using the format of the first one or two authors last name(s) within square brackets “[ ]”, multiple references within a pair of square brackets separated by semicolons “;”

[0086] [Ronse] Ronse, Christian and Devijver, Pierre A., *Connected Components in Binary Images: the Detection Problem*, John Wiley & Sons Inc. New York, 1984;

[0087] [Viberg] Viberg, Mats, *Subspace Fitting Concepts in Sensor Array Processing*, Linköping Studies in Science and Technology. Dissertations No. 27 Linköping, Sweden 1989;

[0088] [Shapiro] Shapiro, Larry S., *Affine Analysis of Image Sequences*, Cambridge University Press, 1995;

[0089] [Hara] Hara, Yoshiko “Matsushita demos multilayer MPEG-4 compression”, *Electronic Engineering Times*, Apr. 19, 1999.

#### 1. An apparatus comprising:

a transparent touchpad positioned over a visual display, the transparent touchpad configured to sense a contiguous region of contact from at least a portion of a human hand on a surface of the transparent touchpad, the transparent touch pad comprising a sensor array having a plurality of sensors, each sensor having a unique spatial location and an associated unique address, wherein the transparent touch pad is configured to sense the contiguous region of contact by a generation of sensor measurement values associated with each of the plurality of sensors;

a plurality of sensor spatial locations having associated sensor measurement values responsive to the contiguous region of contact;

a value of at least one control parameter for the contiguous region of contact responsive to a measured change in at least one of the associated sensor measurement values, the value obtained by performing a calculation on the associated sensor measurement values and interpreting the results as signifying a touch gesture, wherein the at least one control parameter is associated with the touch gesture; and

at least one derived control parameter assigned to a specific control signal;

wherein the touch gesture is recognized from sequential dynamics among postures derived from pressure profiles.

2. The apparatus of claim 1 wherein the transparent touch pad is configured to sense the contiguous region of contact by determining the pressure values and coordinates for selected pixels associated with the portion of the human hand on the surface of the transparent touchpad.

3. The apparatus of claim 1, wherein the transparent touch pad is configured to determine the pressure profiles from a pressure distribution for the contiguous region of contact.

4. The apparatus of claim 1, wherein the transparent touch pad is configured to determine the sequential dynamics among postures based on a pattern for the contiguous region of contact.

5. The apparatus of claim 1, wherein the transparent touch pad is configured to sense the contiguous region of contact by a generation of the associated sensor measurement values based on identifying a point of contact for the sensed region of contact relative to the surface of the transparent touchpad.

6. The apparatus of claim 1, wherein the transparent touchpad is configured to sense the contiguous region of contact by a generation of the associated sensor measurement values based on identifying measurement values that exceed a threshold.

7. The apparatus of claim 1, wherein the transparent touch pad is further configured to track a trajectory of movement of the portion of the human hand contacting the surface of the transparent touchpad.

8. The apparatus of claim 1, wherein the visual display is further configured to provide dynamically assigned labels.

9. The apparatus of claim 1, wherein at least one control parameter is responsive to a geometric center of the contiguous region of measurement values.

10. The apparatus of claim 1, wherein at least one control parameter is responsive to a center of pressure of the contiguous region of measurement values.

11. The apparatus of claim 1, wherein at least one control parameter is responsive to an average pressure of the contiguous region of measurement values.

12. The apparatus of claim 1, wherein at least one control parameter is responsive to a total size of the contiguous region of measurement values.

13. The apparatus of claim 1, wherein the transparent touch pad is further configured to sense at least a second contiguous region of contact from another portion of a human hand on a surface of the transparent touchpad, and the apparatus is configured to derive a value of at least another control parameter responsive to the second contiguous region of contact.

#### 14. An apparatus comprising:

a transparent touch sensor array comprising a plurality of transparent sensors positioned over a display associated with the apparatus to form a transparent touch pad, wherein the transparent touch sensor array is configured to sense contact with one or more fingers on a corresponding contiguous region on the transparent touch pad, wherein each transparent sensor of the plurality of transparent sensors has a corresponding spatial location, associated address, and is configured to provide associated sensor measurement values;

a plurality of control parameters associated with a plurality of postures and a plurality of touch gestures, each of the plurality of touch gestures comprised of sequential dynamics among a set of postures from the plurality of postures, each of the plurality of touch gestures associated with a measured change to at least one of the associated sensor measurement values, wherein each of the plurality of postures is associated with a corresponding pattern of contact of the one or more fingers on the transparent touch pad sensed by the plurality of transparent sensors, wherein at least one of the plurality of control parameters is derived from recognizing one of

the plurality of touch gestures from the corresponding sequential dynamics among postures from the plurality of postures, and  
a plurality of control signals associated with the plurality of control parameters; and wherein the set of postures and gestures correspond to interactions with displayed visual content of an application operating on the apparatus.

**15.** The apparatus of claim **14**, wherein the set of postures are associated with a single continuous touching of the transparent touch sensor array.

**16.** The apparatus of claim **14**, wherein the display is configured to dynamically provide at least one label at a corresponding spatial location of at least one of the plurality for transparent sensors in response to the control signals.

**17.** The apparatus of claim **14**, wherein the display is configured to control displayed visual content based on controlling at least one of a selection, a motion, and a sizing of the displayed visual content.

\* \* \* \* \*