



US008345014B2

(12) **United States Patent**
Lim

(10) **Patent No.:** **US 8,345,014 B2**
(45) **Date of Patent:** ***Jan. 1, 2013**

(54) **CONTROL OF THE OPERATING SYSTEM ON A COMPUTING DEVICE VIA FINGER ANGLE USING A HIGH DIMENSIONAL TOUCHPAD (HDTP) TOUCH USER INTERFACE**

(58) **Field of Classification Search** 345/173-179; 178/18.01-18.04; 463/36-39
See application file for complete search history.

(56) **References Cited**

U.S. PATENT DOCUMENTS

4,899,137	A	2/1990	Behrens et al.	
5,386,219	A	1/1995	Greanias et al.	
6,037,937	A	3/2000	Beaton et al.	
6,323,846	B1	11/2001	Westerman et al.	
6,400,836	B2	6/2002	Senior	
8,169,414	B2 *	5/2012	Lim	345/173

* cited by examiner

Primary Examiner — Kimnhung Nguyen

(74) *Attorney, Agent, or Firm* — Procopio Cory Hargreaves & Savitch LLP; Mainak H. Mehta

(57) **ABSTRACT**

A high dimensional touchpad (HDTP) controls a variety of computer windows systems and applications by detecting a user's finger movement in the left-right, forward-backward, roll, pitch, yaw, and downward pressure directions. One or more of the detected finger movements are then used to control specific computer applications including focusing a user's attention to one of several web pages, gesture recognition, magnification control, 3D-polyhedral menu selection, Internet browsers, navigation applications, games, media players, spreadsheets, and controlling the functions of mobile devices.

20 Claims, 24 Drawing Sheets

(75) **Inventor:** **Seung E. Lim**, Belmont, CA (US)

(73) **Assignee:** **Lester F. Ludwig**, Belmont, CA (US)

(*) **Notice:** Subject to any disclaimer, the term of this patent is extended or adjusted under 35 U.S.C. 154(b) by 766 days.

This patent is subject to a terminal disclaimer.

(21) **Appl. No.:** **12/502,230**

(22) **Filed:** **Jul. 13, 2009**

(65) **Prior Publication Data**

US 2011/0007000 A1 Jan. 13, 2011

Related U.S. Application Data

(60) Provisional application No. 61/080,232, filed on Jul. 12, 2008.

(51) **Int. Cl.**
G06F 3/041 (2006.01)

(52) **U.S. Cl.** 345/173; 345/179; 463/36; 178/18.01

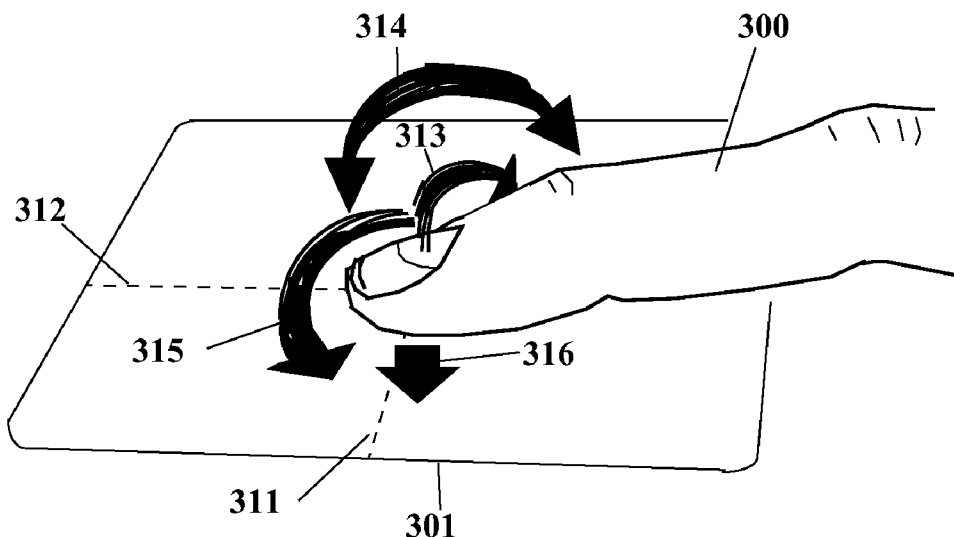

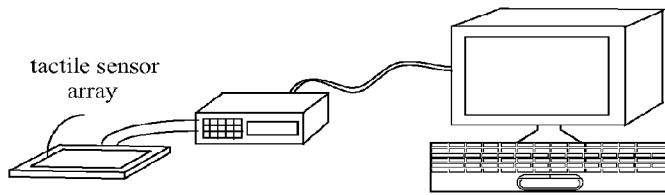

Figure 1a

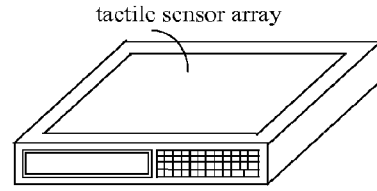

Figure 1d

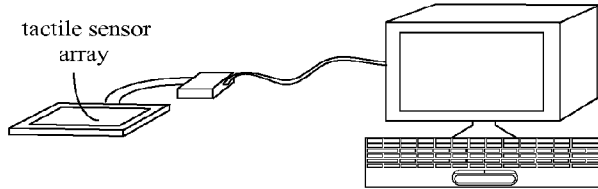

Figure 1b

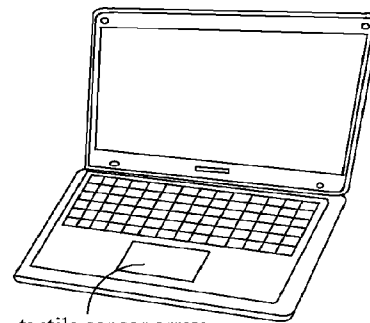

Figure 1e

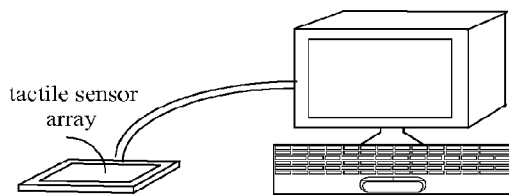

Figure 1c

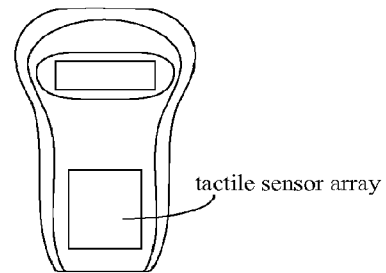

Figure 1f

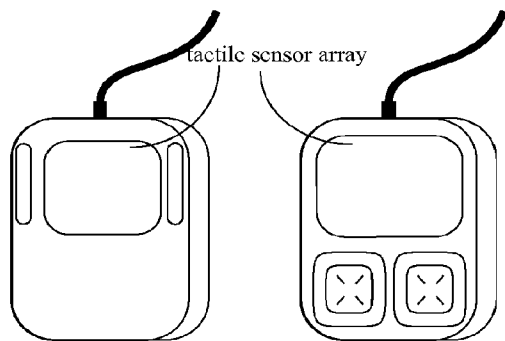

Figure 1g

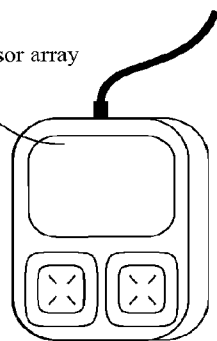

Figure 1h

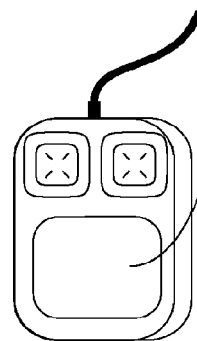

Figure 1i

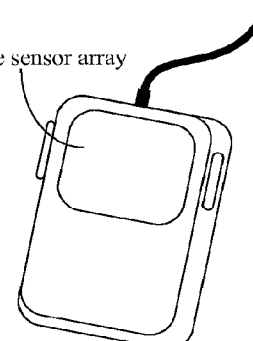

Figure 1j

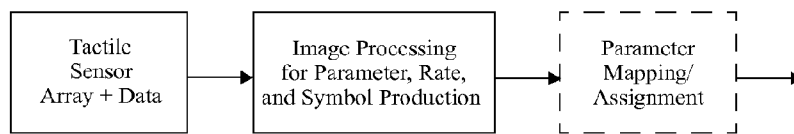

Figure 2a

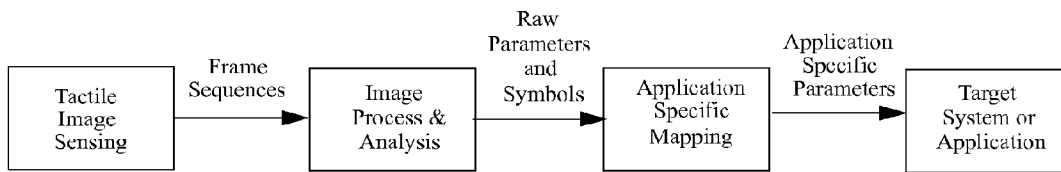

Figure 2b

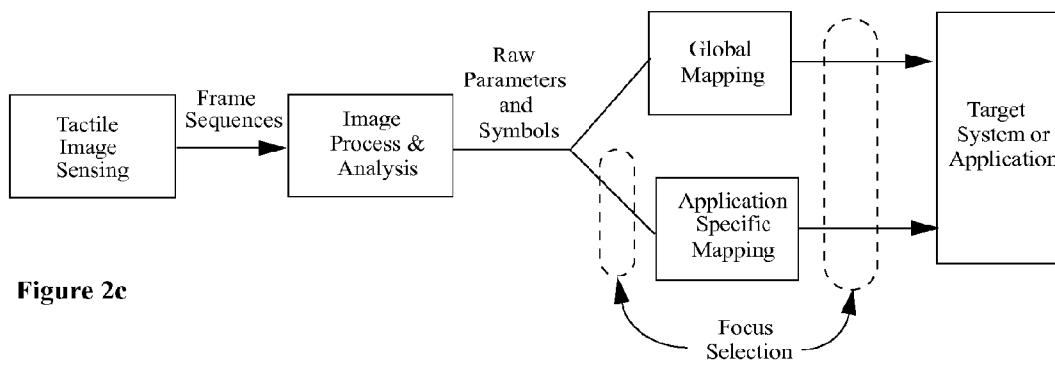

Figure 2c

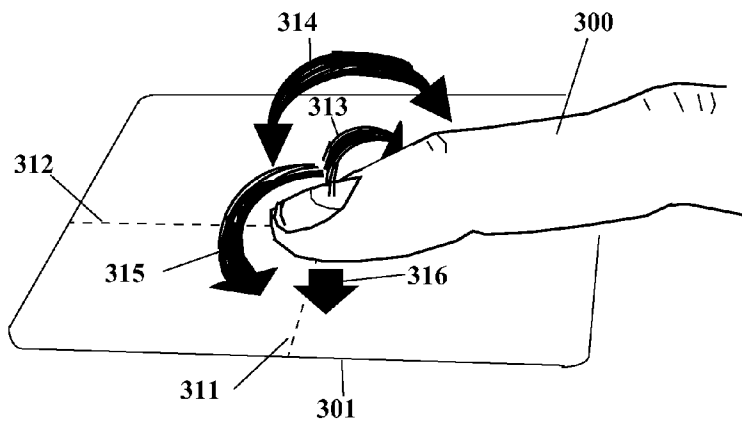

Figure 3

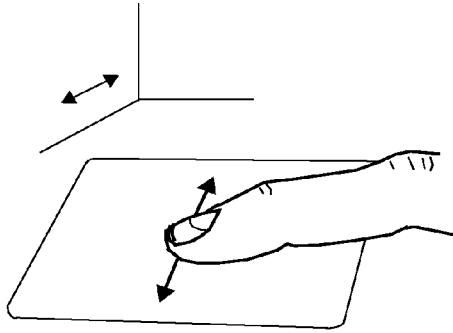

Figure 4a

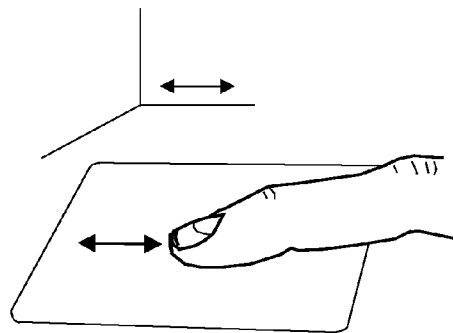

Figure 4b

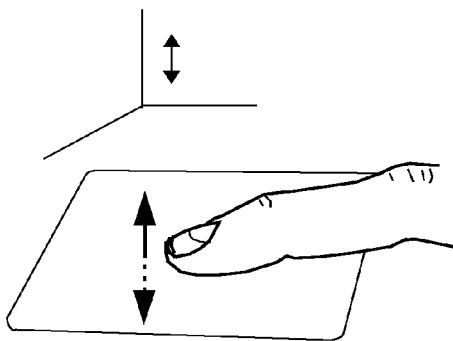

Figure 4c

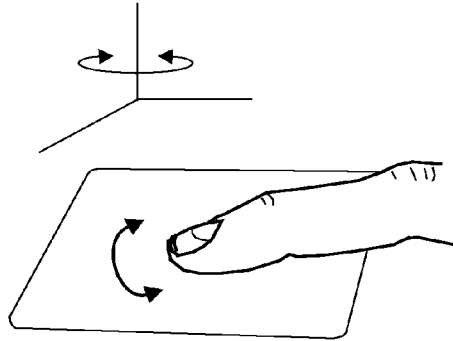

Figure 4d

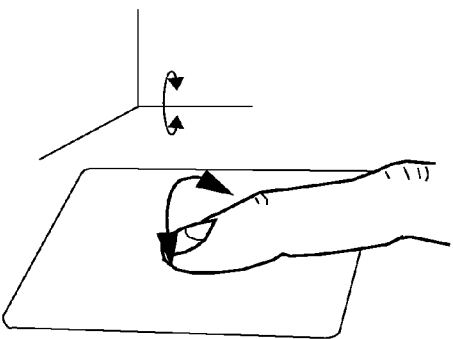

Figure 4e

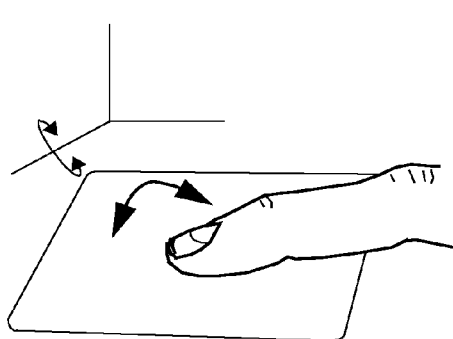

Figure 4f

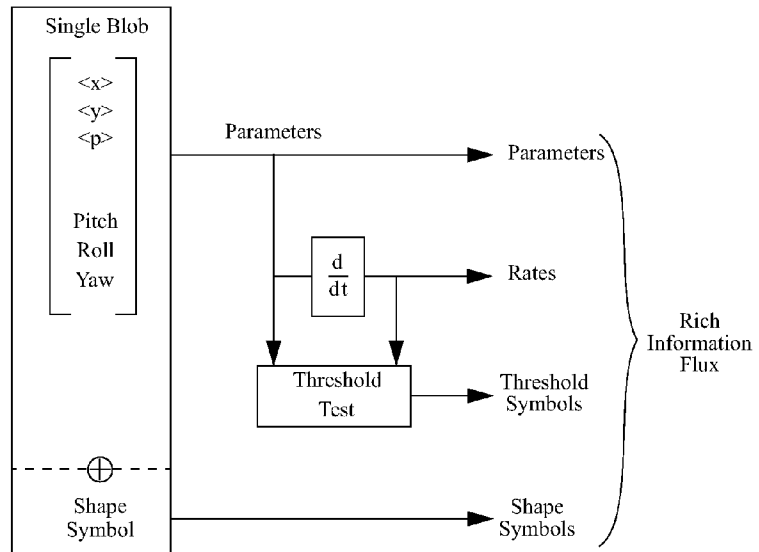

Figure 5

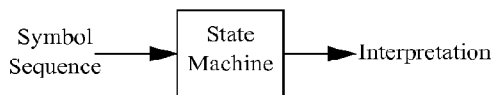

Figure 6a

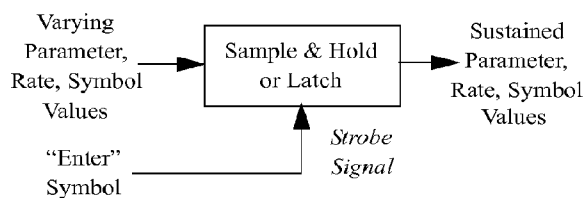

Figure 6b

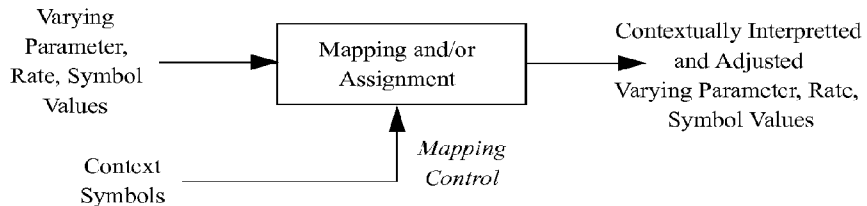

Figure 6c

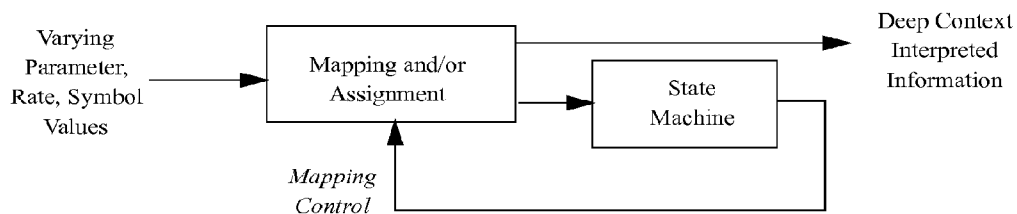

Figure 6d

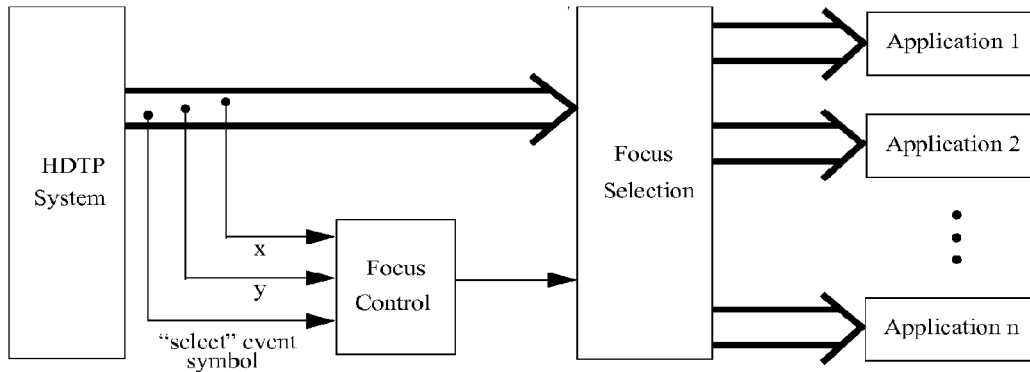

Figure 6e

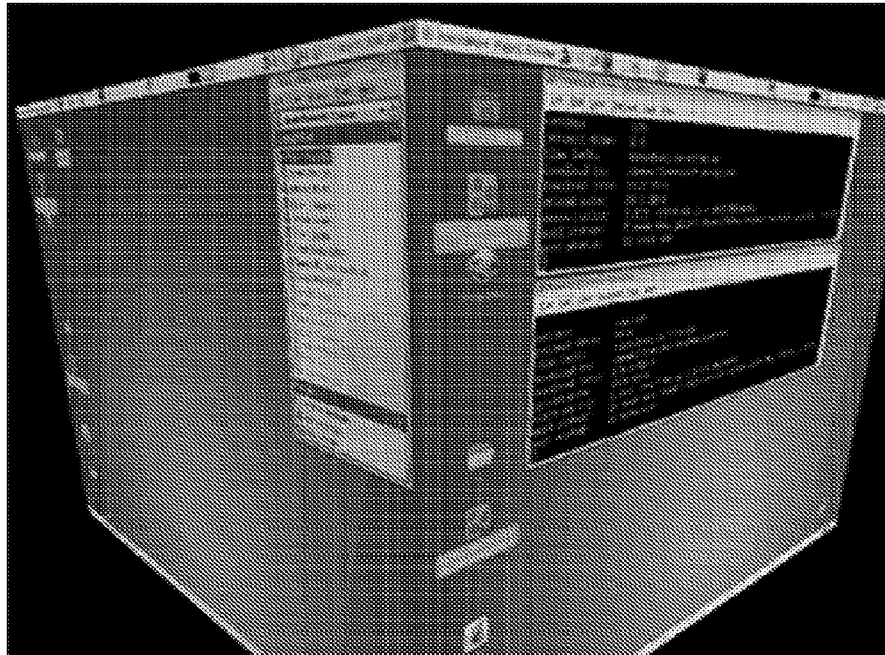

Figure 7

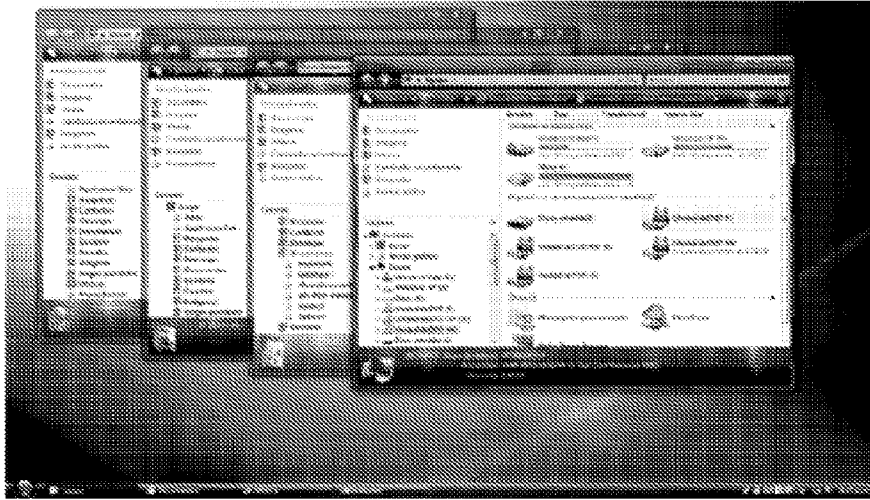

Figure 8

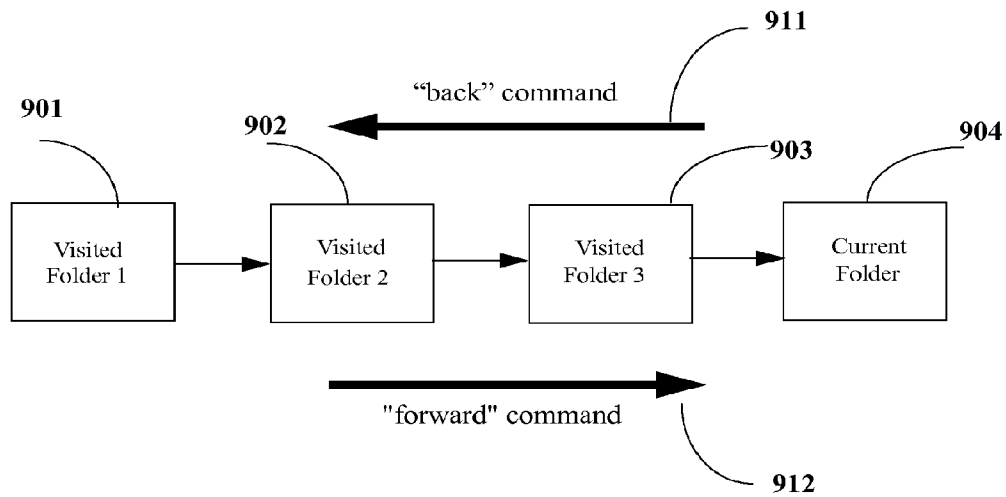

Figure 9

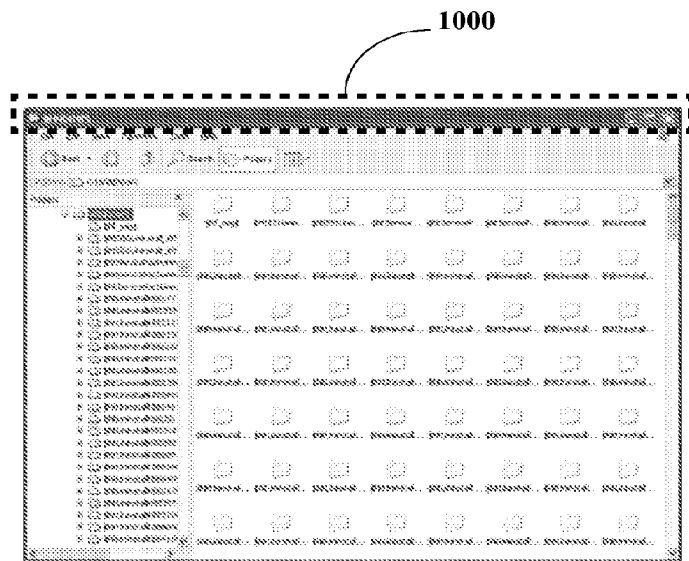

Figure 10a

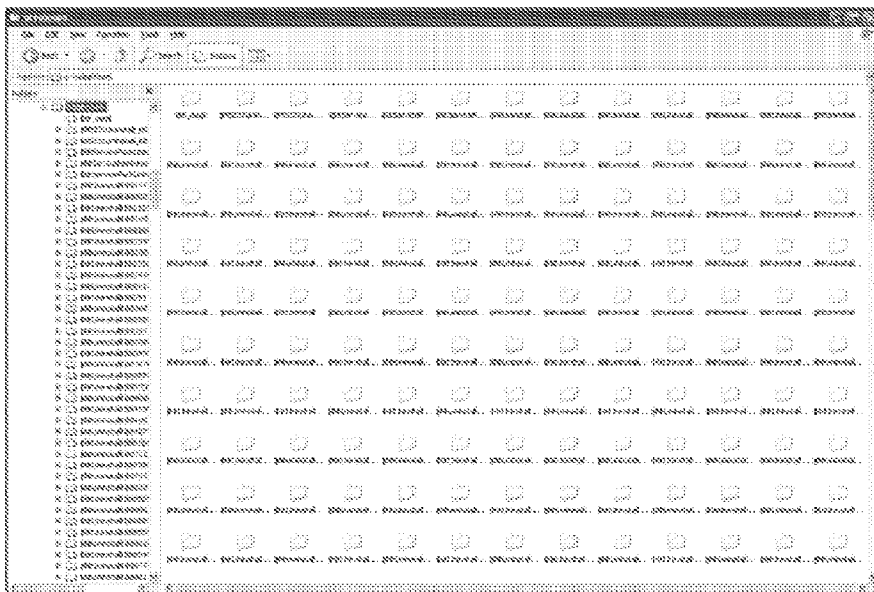

Figure 10b

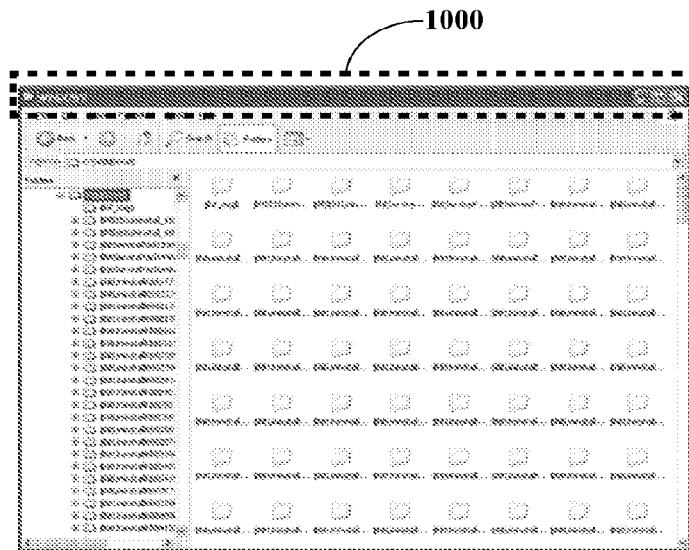

Figure 10c

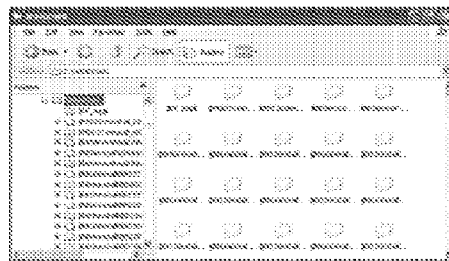

Figure 10d

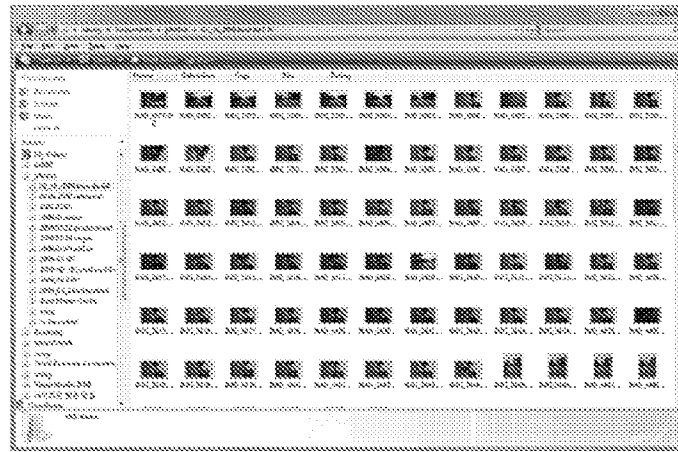

Figure 11a



Figure 11b



Figure 11c

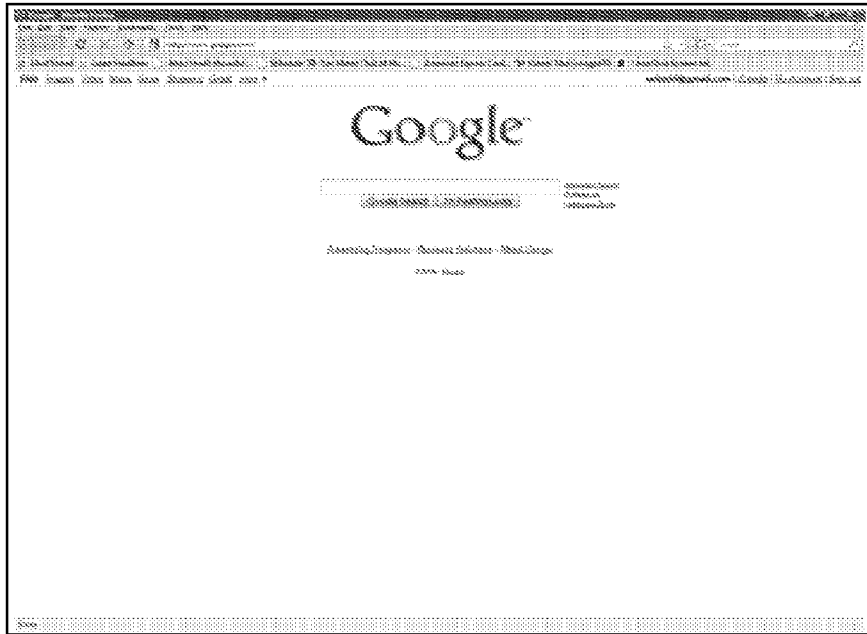

Figure 12a

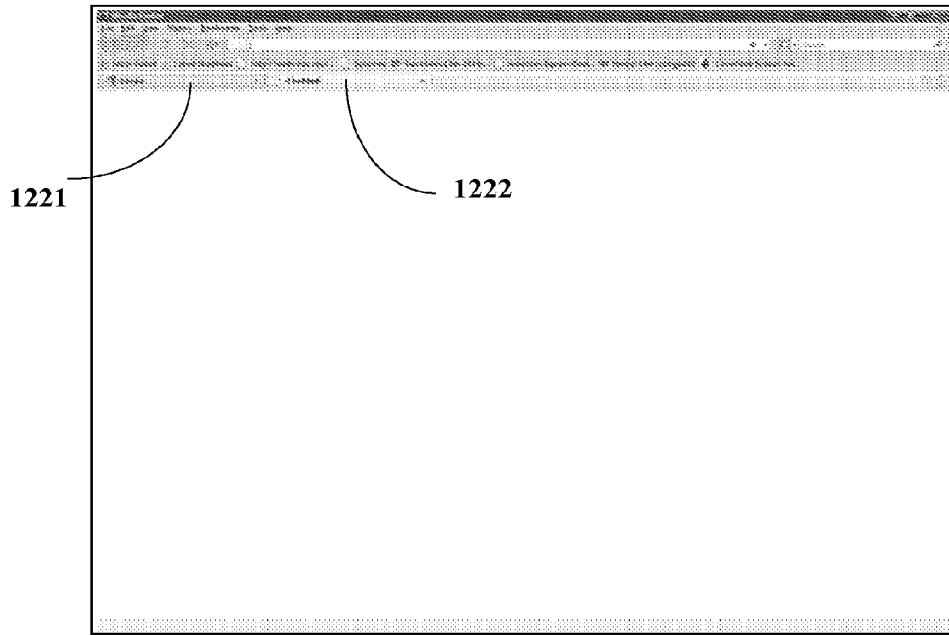

Figure 12b

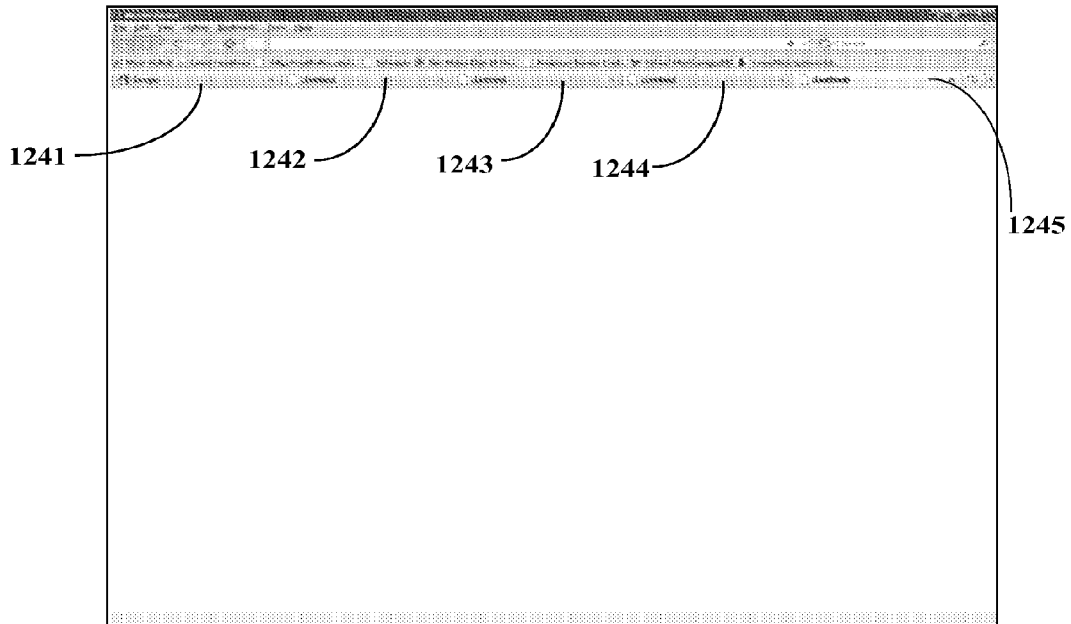

Figure 12c

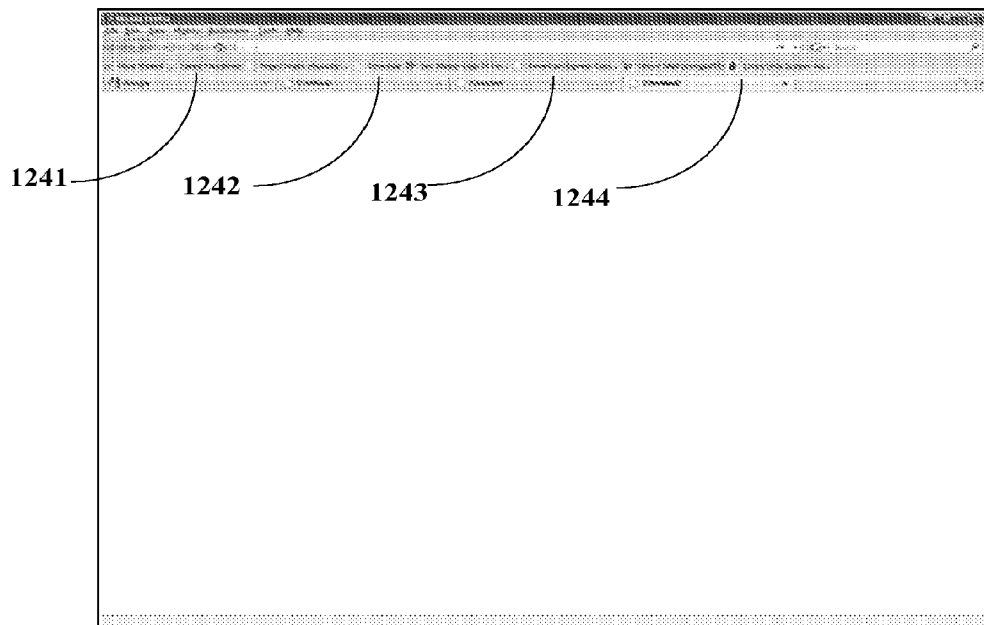

Figure 12d

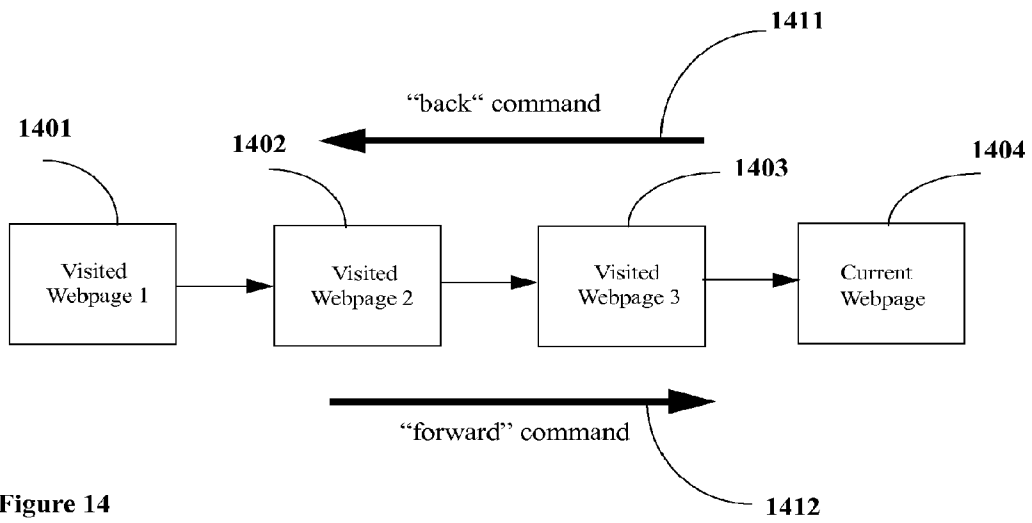

Figure 14

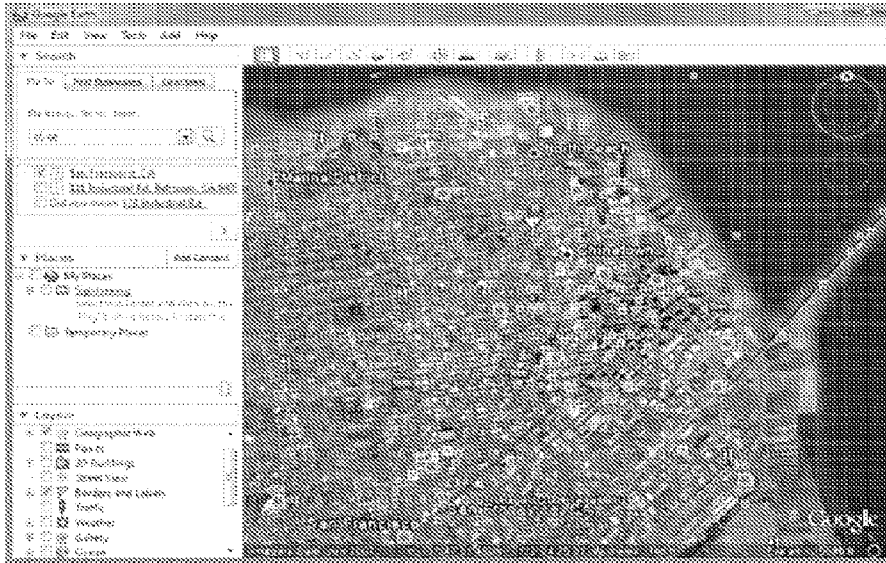

Figure 15a

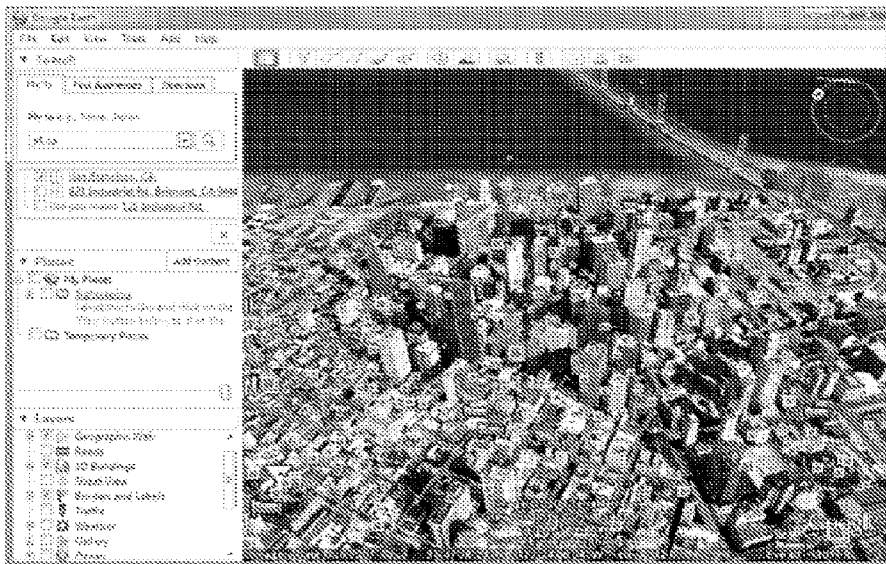

Figure 15b



Figure 16a



Figure 16b

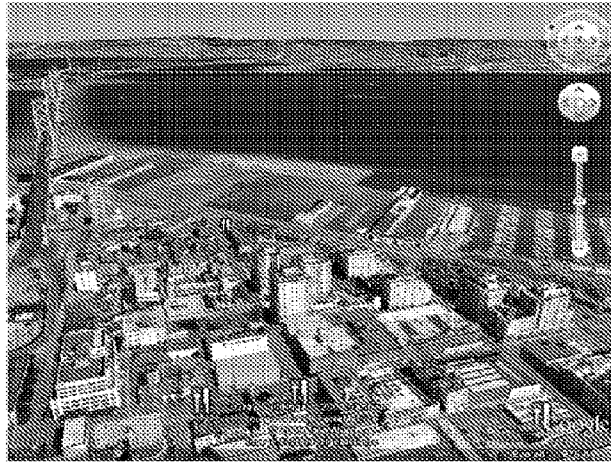

Figure 17a

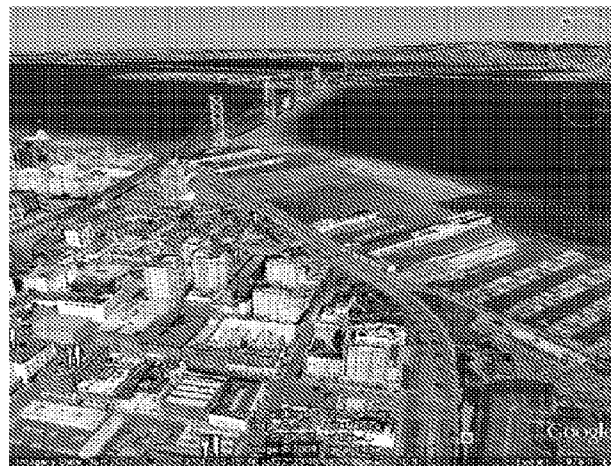

Figure 17b



Figure 17c

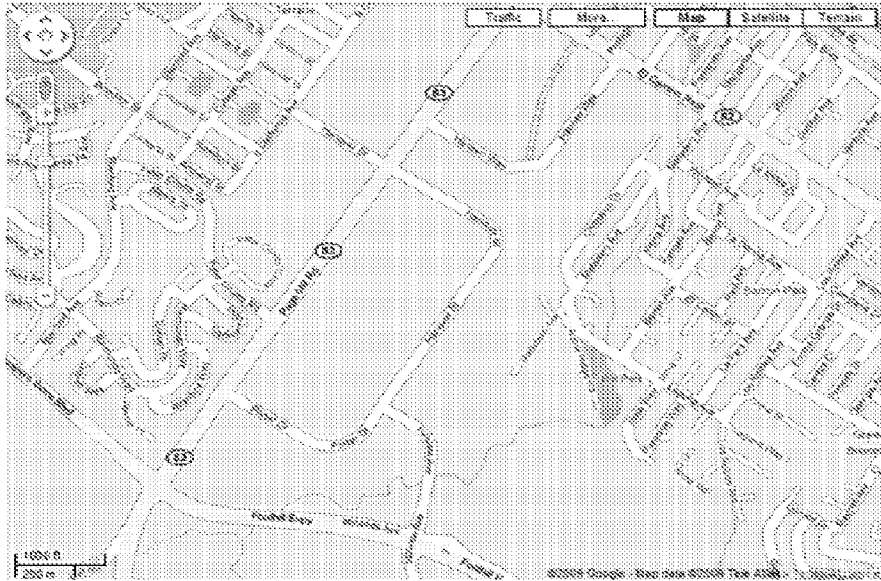

Figure 18a

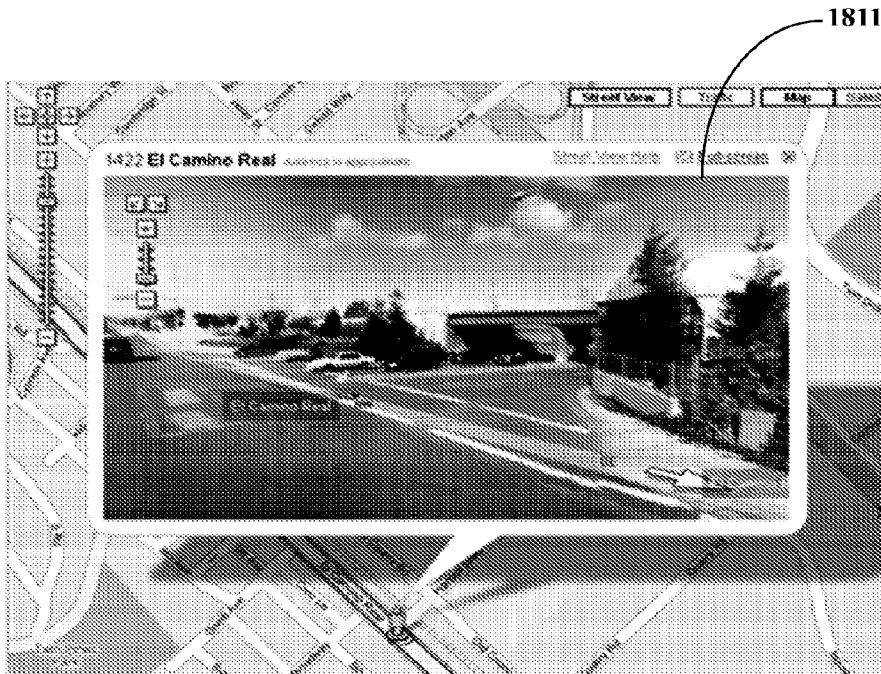

Figure 18b

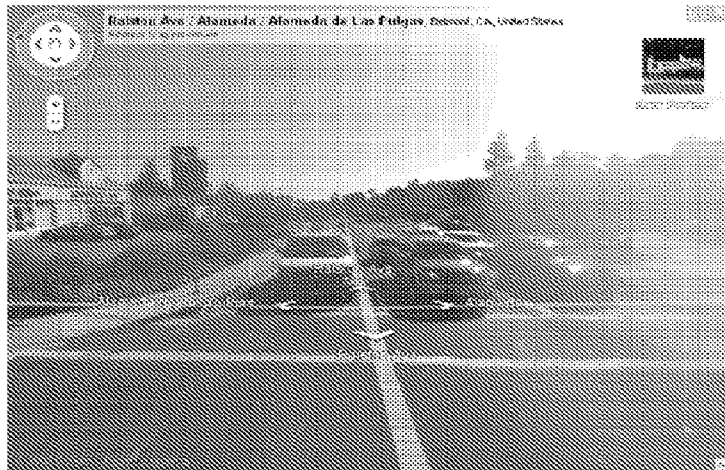

Figure 18c



Figure 18d

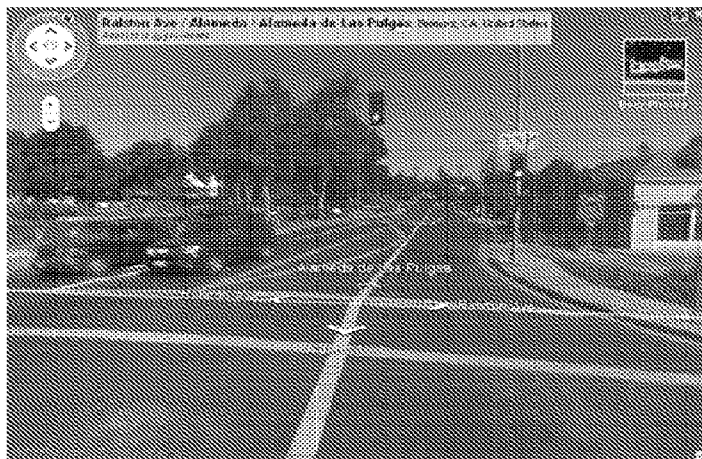

Figure 18e

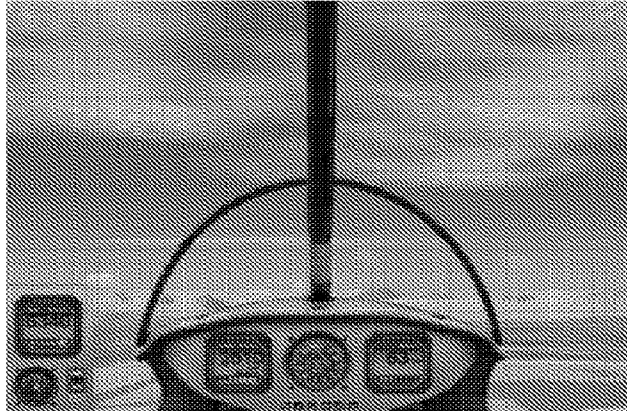

Figure 19a



Figure 19b

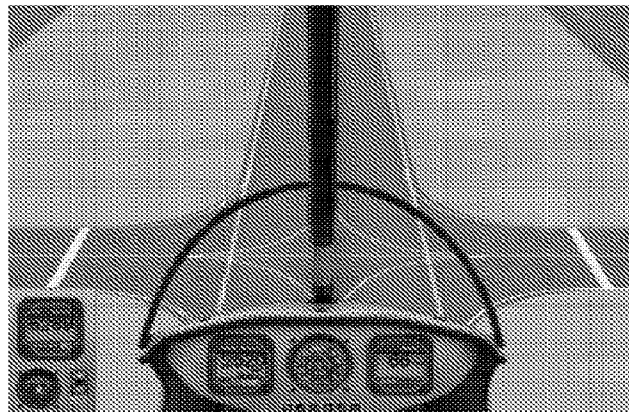

Figure 19c



Figure 20a

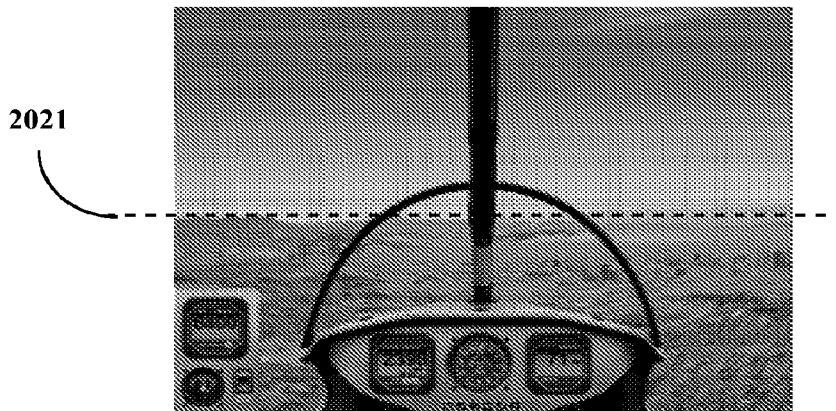

Figure 20b

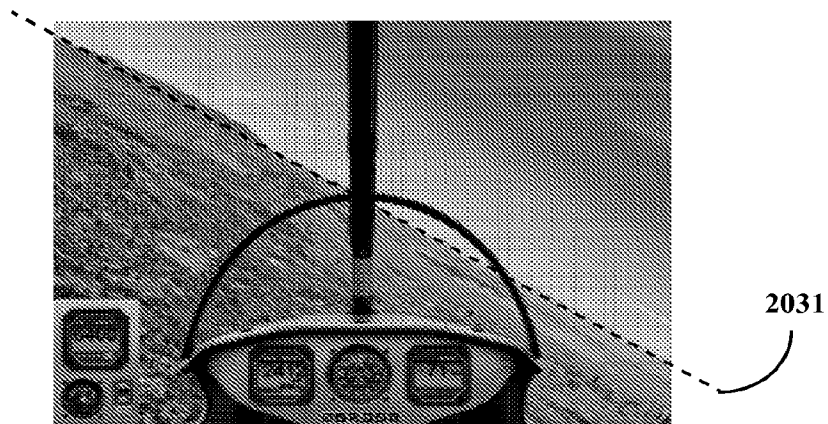

Figure 20c

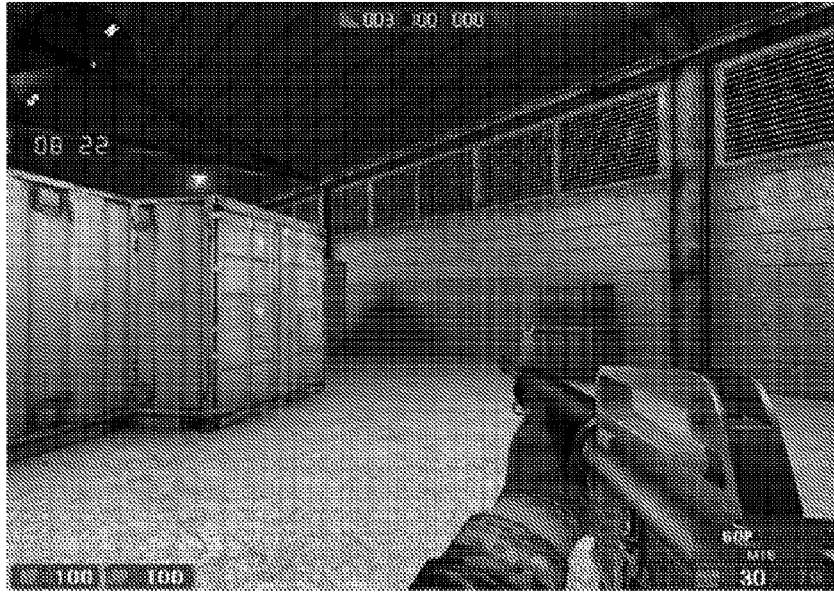

Figure 21a

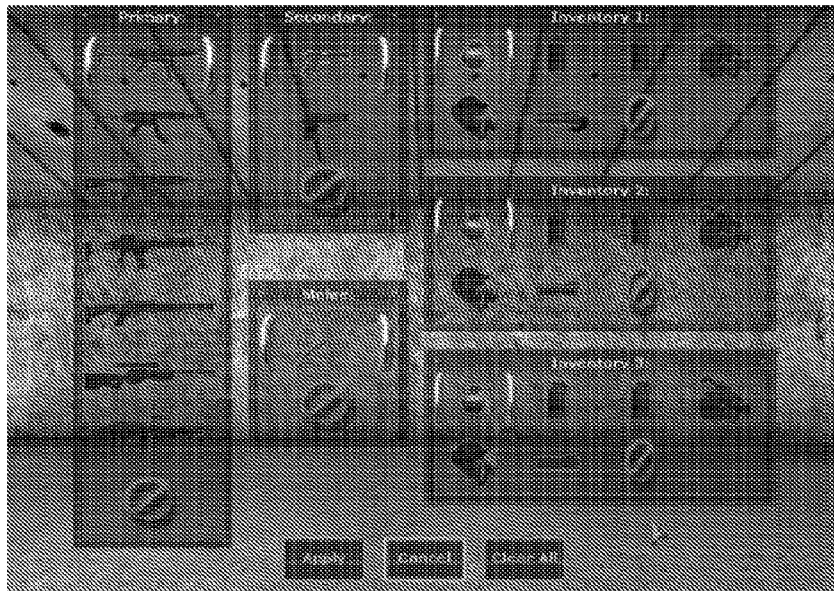

Figure 21b

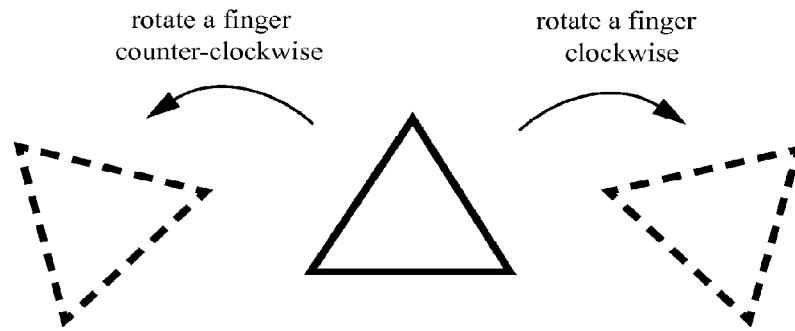

Figure 22

**CONTROL OF THE OPERATING SYSTEM ON
A COMPUTING DEVICE VIA FINGER
ANGLE USING A HIGH DIMENSIONAL
TOUCHPAD (HDTP) TOUCH USER
INTERFACE**

CROSS-REFERENCE TO RELATED
APPLICATIONS

This application claims priority from U.S. Provisional Application U.S. 61/080,232, filed Jul. 12, 2008.

FIELD OF THE INVENTION

This invention relates to the use of a High Dimensional Touchpad (HDTP) providing enhanced parameter capabilities to the control computer window systems, computer applications, web applications, and mobile devices, by using finger positions and motions comprising left-right, forward-backward, roll, pitch, yaw, and downward pressure of one or more fingers and/or other parts of a hand in contact with the HDTP touchpad surface.

DESCRIPTION OF THE RELATED ART

The incorporation of the system and method of the invention allows for enhanced control of at least computer window systems, computer applications, web applications, and mobile devices. The inclusion of at least one of roll, pitch, yaw, and downward pressure of the finger in contact with the touchpad allows more than two user interface parameters to be simultaneously adjusted in an interactive manner. Contact with more than one finger at a time, with other parts of the hand, and the use of gestures, grammar, and syntax further enhance these capabilities.

The invention employs an HDTP such as that taught in issued U.S. Pat. No. 6,570,078, and U.S. patent application Ser. Nos. 11/761,978 and 12/418,605 to provide easier control of application and window system parameters. An HDTP allows for smoother continuous and simultaneous control of many more interactive when compared to a mouse scroll wheel mouse. Tilting, rolling, or rotating a finger is easier than repeatedly clicking a mouse button through layers of menus and dialog boxes or dragging and clicking a button or a key on the keyboard. Natural metaphors simplify controls that are used to require a complicated sequence of actions.

SUMMARY OF THE INVENTION

In an embodiment, the invention includes a system and method for controlling an electronic game, the method comprising touching a touchpad with at least one finger, measuring at least one change in one angle of the position of the finger with respect to the surface of the touchpad and producing a measured-angle value, and using the measured-angle value to control the value of at least one user interface parameter of the electronic game.

In an embodiment, the invention includes a system and method for controlling a polyhedral menu, the method comprising touching a touchpad with at least one finger, measuring at least one change in one angle of the position of the finger with respect to the surface of the touchpad and producing a measured-angle value, and using the measured-angle value to control the value of at least one user interface parameter of the polyhedral menu.

In an embodiment, the invention includes a system and method for controlling a computer operating system, the

method comprising touching a touchpad with at least one finger, measuring at least one change in one angle of the position of the finger with respect to the surface of the touchpad and producing a measured-angle value, and using the measured-angle value to control the value of at least one user interface parameter for controlling the computer operating system.

In an embodiment, the invention includes a system and method for controlling the observation viewpoint of a three-dimensional (3D) map, the method comprising touching a touchpad with at least one finger, measuring at least one change in one angle of the position of the finger with respect to the surface of the touchpad and producing a measured-angle value, and using the measured-angle value to control the value of at least one user interface parameter for controlling the observation viewpoint of the 3D map.

In an embodiment, the invention includes a system and method for controlling the observation viewpoint of a surrounding photographic emersion, the method comprising touching a touchpad with at least one finger, measuring at least one change in one angle of the position of the finger with respect to the surface of the touchpad and producing a measured-angle value, and using the measured-angle value to control the value of at least one user interface parameter for controlling the observation viewpoint of the surrounding photographic emersion.

In an embodiment, the invention includes a system and method for controlling the orientation of a simulated vehicle, the method comprising touching a touchpad with at least one finger, measuring at least one change in one angle of the position of the finger with respect to the surface of the touchpad and producing a measured-angle value, and using the measured-angle value to control the value of at least one user interface parameter for controlling the orientation of a simulated vehicle.

In an embodiment, the invention includes a system and method for controlling the rotational angle of a graphical object, the method comprising touching a touchpad with at least one finger, measuring at least one change in one angle of the position of the finger with respect to the surface of the touchpad and producing a measured-angle value, and using the measured-angle value to control the value of at least one user interface parameter for controlling the rotational angle of a graphical object.

The invention will be described in greater detail below with reference to the accompanying drawings.

BRIEF DESCRIPTION OF THE DRAWINGS

The accompanying drawings, which are included to provide a further understanding of the invention and are incorporated in and constitute a part of this specification, illustrate embodiments of the invention and together with the description serve to explain the principles of the invention.

FIGS. 1a-1j illustrate exemplary arrangements and physical formats employing an HDTP touchpad. The exemplary component tactile image sensor, interface electronics, and a processor may be included collectively as components of laptop computers, mobile phones, mobile devices, remote control devices, etc.

FIG. 2a depicts an exemplary realization wherein a tactile sensor array is provided with real-time or near-real-time data acquisition capabilities. FIGS. 2b and 2c illustrate exemplary data flows in an embodiment of an HDTP system.

FIG. 3 illustrates how a finger can simultaneously adjust several or all of the parameters with viable degrees of independent control.

FIGS. 4a-4f illustrate exemplary six parameters that can be independently controlled by the user and subsequently recorded by algorithmic processing as provided by the invention.

FIG. 5 illustrates an exemplary embodiment wherein parameters, rates, and symbols may be generated in response to the user's contact with a tactile sensor array, which in turn may be interpreted as parameterized postures, gestures, parameterized gestures, etc.

FIGS. 6a-6d depict exemplary operations acting on various parameters, rates, and symbols to produce other parameters, rates, and symbols, including operations such as sample/hold, interpretation, context, etc., which in turn may be used to implement parameterized further details of postures, gestures, parameterized gestures, etc. and their use by systems and applications.

FIG. 6e shows an exemplary embodiment wherein some parameters and events are tapped and used for focus control and selection.

FIG. 7 illustrates an exemplary polyhedron desktop featured by some contemporary operating systems.

FIG. 8 illustrates an exemplary feature of some operating systems that shows a preview of each open window.

FIG. 9 illustrates an exemplary set of file folders visited by file browser and the direction of flow in the browse history.

FIGS. 10a-10d depict exemplary file browser windows whose dimension is controlled by interpreted gestures of a user.

FIGS. 11a-11c illustrate exemplary file browser windows, comprising various sizes of icons, which can be controlled by interpreted gestures made by a user.

FIGS. 12a-12d illustrate exemplary internet browser windows.

FIG. 13a illustrates an exemplary internet browser window with a word highlighted function invoked by a user. FIG. 13b illustrates an exemplary internet browser window displaying the definition of the highlighted word in FIG. 13a.

FIG. 14 illustrates an exemplary set of previously visited webpages and the direction of flow in the browsing history.

FIG. 15a illustrates an exemplary initial screen view of a geographic information program.

FIG. 15b illustrates an exemplary screen view with adjusted observation point.

FIGS. 16a and 16b illustrate exemplary screen views of geographic information system with varied vertical observation points.

FIGS. 17a-17c illustrate exemplary screen views of geographic information system with varied horizontal observation points.

FIG. 18a illustrates an exemplary screen view of a web mapping service application.

FIG. 18b illustrates an exemplary screen view of a web mapping service application with a feature that displays panoramic views from a position on the map.

FIGS. 18c-18e illustrate exemplary screen views of a web mapping service application with a feature that displays panoramic views along the street.

FIGS. 19a-c illustrate exemplary screen views of a flight simulator game where the view from an aircraft is pitched upward or downward.

FIGS. 20a-c illustrate exemplary screen views of a flight simulator game where the vertical orientation of an aircraft is rolled counter-clockwise or clockwise.

FIG. 21a illustrates an exemplary screen view of a first-person shooter game.

FIG. 21b illustrates an exemplary screen view of a weapon selection window of a first-person shooter game.

FIG. 22 illustrates an exemplary application of an object being rotated by interpreted gestures of a user in a computer aided design/drafting application.

DETAILED DESCRIPTION OF THE INVENTION

The present invention provides for the control of computer window systems, computer applications, and web applications using an HDTP in user interfaces that capture not only left-right and forward-back positions of a finger in contact with the touchpad surface but also finger motions and positions comprising roll, pitch, yaw, and downward pressure of the finger in contact with the touchpad.

FIGS. 1a-1j illustrate exemplary setup physical formats employing such an HDTP system. In some embodiments, such an HDTP system comprises of a tactile sensor array, interface electronics, and at least one processor.

An exemplary tactile sensor array embodiment may comprise regular arrays of pressure-measurement, proximity-measurement, optical-measurement, or other measurement elements or cells. However, other types of sensors adapted to sense at least a tactile image, a pressure image, a proximity image, or an optical image resulting from a finger, multiple fingers, and/or other hand contact with the touchpad are also provided for by the invention.

As shown in FIG. 1a, exemplary interface hardware may provide associated controls and/or visual indicators or displays. Alternatively, as illustrated in FIG. 1b, associated controls may be part of a Graphical User Interface (GUI) operating on the associated computer or on other articles of equipment. A tactile image sensor system and associated interface hardware also may be configured to share the same housing with the system or portions of it as shown in FIG. 1c. The tactile image sensor system, interface electronics, and a processor may also be configured to share a common housing environment as shown in FIG. 1d. A tactile image sensor system can be a part of mobile device as shown in FIG. 1e, and such device can be configured to work as a remote control system as shown in FIG. 1f. In an embodiment, sensor array and interface hardware may be implemented as a touchpad module within a laptop or a personal computer as shown in FIG. 1e. The tactile sensor array may be configured to be used as a touchpad element incorporated into a handheld device, such as a field measurement instrument, bench test instrument, Personal Digital Appliance (PDA), cellular phone, signature device, etc. An exemplary depiction of another exemplary handheld device, as may be used in commerce, services, or industry, is shown in FIG. 1f. A tactile image sensor system can be added to the back of a mouse, for example as in depicted in FIGS. 1g-1j.

In an exemplary embodiment, a tactile image sensor system comprises a tactile sensor which in turn comprises an array of tactile measurement cells. Each tactile measurement cell detects a measurable tactile quantity as a numerical value, and interface hardware sends such numerical data to the processor where the data are processed and transformed into information describing the position and movement of a finger, multiple fingers, or other part of the hand, etc.

A key feature of the touchpad HDTP is its capability to process and extract values of parameters from tactile images in real-time or near real-time. FIG. 2a illustrates an exemplary dataflow embodiment. In this example, the tactile image sensor system may be periodically scanned or otherwise produce an ongoing sequence or snapshot of tactile images. In analogy with visual images, each such tactile image in the sequence may be called a "frame." In this example, each frame is directed to image analysis software where algo-

rithms and/or hardware are used to calculate or extracts a number of parameters associated with hand contact attributes of the tactile image frame.

FIG. 2*b* illustrates a first exemplary data flow in an embodiment of an HDTP system. Here, a Tactile Image Sensing element provides real-time tactile image data. In some embodiments, this real-time tactile image data may be advantageously organized in a pre-defined manner, for example as an ongoing sequence of “frames” similar to those comprised by motion video).

The real-time tactile image data is presented to an Image Process and Analysis element such as those in the previously cited patents and/or those to be described later. The Image Process and Analysis element may be configured to responsively produce values or streams of values of raw parameters and symbols. In some embodiments, these raw parameters and symbols do not necessarily have any intrinsic interpretation relative to specific applications, systems, or a computer operating system. In other embodiments, the raw parameters and symbols may in-part or in-full have intrinsic interpretation. In embodiments where raw parameters and symbols do not have an intrinsic interpretation relative to applications, a system, or a computer operating system, the raw parameters may be presented to an Application Specific Mapping element. Such an Application Specific Mapping element may responsively produce Application-Specific parameters and symbols that are directed to a Target System or Application.

In some multi-application situations or embodiments, some raw parameters and symbols may be assigned or interpreted in a universal or globally applicable way while other raw parameters and symbols may be assigned or interpreted in an application-specific manner. FIG. 2*c* illustrates a second exemplary data flow in an embodiment of an HDTP system which incorporates this consideration. Here, the raw parameters and symbols may be directed to a both a Global or Universal Mapping element and an Application Specific Mapping element. The output of each of these elements is directed to a Target System or Application as directed by a focus selection element (for example, as found in a computer windowing system). The same focus selection element may also be used to simultaneously direct the raw parameters and symbols to a particular Application Specific Mapping element that is associated with the Target System or Application.

Many variations, combinations, and reorganizations of these operations and concepts are possible as is clear to one skilled in the art. Such variations, combinations, and reorganizations of these operations and concepts are provided for by the invention.

FIGS. 3*a-3f* illustrate six exemplary parameters that can be independently controlled by the user and subsequently recorded by algorithmic processing as provided for by invention. These six exemplary parameters are:

left-right translation (FIG. 3*a*), sometimes referred as “sway;”

forward-back translation (FIG. 3*b*), sometimes referred as “surge;”

more-less downward pressure (FIG. 3*c*), sometimes referred to as “heave;”

rotation (FIG. 3*d*), sometimes referred to as “yaw;”

left-right tilt (FIG. 3*e*), sometimes referred to as “roll;”

forward-backward tilt (FIG. 3*f*), sometimes referred to as “pitch.”

These parameters may be adjusted individually, in sequence, or simultaneously. Combining these parameters allow numerous degrees of freedom. As demonstrated in FIG. 4, the finger 400 can readily, interactively, and simultaneously

adjust several or all of the parameters simultaneously and with viable degrees of independent control.

FIG. 5 illustrates an exemplary embodiment which can transform simple contact with (or other operative stimulus of) the sensor array into a rich information flux of parameter, rate, and symbol values. Together with the rich metaphors available with the touch interface, a tremendous range of synergistic user interface opportunities can be provided by the HDTP. The rich information flux of parameter, rate, and symbol values in turn may be interpreted as parameterized postures, gestures, parameterized gestures, etc. as may be advantageous for a system and/or applications.

The HDTP provides for additional capabilities. For example, a sequence of symbols may be directed to a state machine, as shown in FIG. 6*a*, to produce other symbols that serve as interpretations of one or more possible symbol sequences. In an embodiment, one or more symbols may be designated to carry the meaning of an “Enter” key, permitting for sampling one or more varying parameter, rate, and/or symbol values and holding the value(s) until, for example, another “Enter” event, thus producing sustained values as illustrated in FIG. 6*b*. In an embodiment, one or more symbols may be designated as setting a context for interpretation or operation and thus control mapping and/or assignment operations on parameter, rate, and/or symbol values as shown in FIG. 6*c*. The operations associated with FIGS. 6*a-6c* may be combined to provide still further capabilities. For example, the exemplary arrangement of FIG. 6*d* shows mapping and/or assignment operations that feed an interpretation state machine which in turn controls mapping and/or assignment operations. In implementations where context is involved, such as in arrangements such as those depicted in FIGS. 6*b-6d*, the invention provides for both context-oriented and context-free production of parameter, rate, and symbol values. The parallel production of context-oriented and context-free values may be useful to drive multiple applications simultaneously, for data recording, diagnostics, user feedback, and a variety of other uses. All of these be used to implement parameterized further details of postures, gestures, parameterized gestures, etc. and their use by systems and applications.

In an embodiment, the measured parameters, derived by the tactile image data, can be either used directly or transformed into other types of control signals. The tactile image data can also be presented to shape and image recognition processing. This could be done in post-scan computation although aspects could be performed during scanning in some embodiments. In some implementations, shape and/or image recognition may be applied to interpreting the tactile image measurements. In other embodiments, shape and/or image recognition may be used to assist with or even implement tactile image measurements.

In each of the exemplary applications described below, the invention provides for any of the cited example postures and gestures to be interchanged with others as may be advantageous in an implementation.

Focus Control

In many systems, especially ones comprising multiple applications or diverse data-entry mechanisms, the information stream produced by an HDTP may need to be selectively directed to a specific application or window. In such systems, it may be useful to use some of the information produced by the HDTP for controlling which destination other information produced by the HDTP is to be directed to. As mentioned earlier in conjunction with FIG. 2*c*, these functions are referred to as focus control and focus selection.

As an example, FIG. 6e shows an HDTP system directing an information stream comprising for example of parameters, rates, and symbols to a Focus Selection element under the control of Focus Control element. The Focus Control element uses a selected subset of the information stream provided by the HDTP to interpret the user's intention for the direction of focus among several windows, applications, etc. The figure shows only applications, but some of these can be replaced with application child windows, operating system, background window, etc. In this example, focus may be controlled by an {x,y} location threshold test and a "select" symbol event, although other information may be used in its place.

Gestures

A gesture refers to motion of a finger, fingers, other part of the hand, or combinations of these used to direct the system with commands. Gesture recognition facilities provided by the HDTP or subsequent or associated system may be used to recognize specific changes within or between postures and resultantly invoke commands associated with a corresponding recognized gesture. In some embodiments, gestures may be recognized only on rates of change of underlying measured parameters provided by the HDTP. In some embodiments, gesture recognition may also comprise state machines driven by threshold events in measured parameters and/or rates of change of underlying measured parameters provided by the HDTP.

Temporal Delimiting of Gestures

The invention provides for the system to discern and recognize an individual gesture or a series of gestures. In such embodiments, it may be advantageous to incorporate a time delay after user makes a gesture to enhance controllability. For example, if the system recognizes a gesture and execute right away, a tap followed by rotating finger would be executed as two separate events: rotate, then a single-click.

To distinguish whether a gesture is separate or part of a combined gesture, an exemplary system may detect moments in time where there is no contact on the tactile sensor array. An exemplary system may also detect moments in time where there is no appreciable changes in the tactile image captured by the tactile sensor array. In an embodiment, the system may be configured to have default or user-accustomed period of delay. In an embodiment, the system may be configured so that if another gesture continuously follows, then the gesture is determined to be part of combination of gestures. In an embodiment, the system may be configured so that a combination and/or sequence of gestures may be viewed as another gesture. In an embodiment, the system may be configured so that a combination and/or sequence of gestures may be viewed as a sentence of gestures. In an embodiment, the system may be configured so that a combination and/or sequence of gestures is subject to syntax and/or grammar constraints. In an embodiment, the system may be configured so that if the gesture is followed by non-contact, the gesture is determined to be independent and corresponding action is to be taken.

Global (Universal) and Context-Specific Gestures

Some of the gestures may be used as global commands; commands that are common across applications or the system. These commands include but are not limited to opening, closing, and switching between applications, opening a windows task manager, save, print, undo, redo, copy, cut, or paste (similar to commands by control key, Windows™ key, function keys, or Apple™ command key). Usually these controls are also provided by application specific menus within a specific application. Applications may assign unique gestures that are recognized only within the specific application. While the system is being used to control specific tasks within

applications, it can be interrupted to control the whole system when global gestures are recognized. When a global gesture is recognized, it is executed regardless of which specific application is focused. When an application specific gesture is recognized, it will be interpreted within the application that has current focus.

In some embodiments, more complex or rarely used gestures (as opposed to simpler or more primitive gestures) may be advantageously assigned to act as global gestures. A rationale for this is that there is far less likelihood that a simple gesture would be misinterpreted as a complex gesture than a complex gesture being misinterpreted as a simpler gesture. Similarly, although sometimes three-finger posture or complex three-finger movement may be interpreted as three separate one-finger postures or gestures, an HDTP system will not confuse one-finger gesture for a three finger gesture.

Some context commands or application specific commands can be more easily be undone than some global commands. In many embodiments, misinterpreting some global commands as context command may be less troublesome than context commands being misinterpreted as global command. Additionally, it is in many cases more complicated to undo previously executed global commands. For example, documents that are overwritten by accidental saving are hard to retrieve; it is time consuming to re-open an application that was accidentally closed; accidental print jobs sent are troublesome to stop. Moreover, assigning more complex gestures as global, more degrees of freedom can be available for context gestures.

Exemplary Global Command Gestures

In an exemplary embodiment, a task manager can be opened by a unique gesture. For example, the user may press downward with three fingers at once, or bringing three spread fingers together. Other exemplary embodiments may include the following "Global" or "Universal" commands that can be rendered while the focus is directed to a particular application:

To open a new document, the user can drag two fingers to the right;

To close an open document, the user can drag two fingers to the left;

To save an open document, the user can roll the finger to the right, bring it to the center, and roll the finger to the left.

An undo command can be implemented by rotating a finger counter-clockwise and tapping with two other fingers;

A redo command can be implemented by rotating a finger clockwise and tapping with two other fingers.

A copy command can be implemented by pitching a finger up and tapping with another finger;

A cut command can be implemented by pitching a finger up and tapping with two other finger;

A paste command can be implemented by pitching a finger down and tapping with another finger.

A print command can be implemented by applying pressure on the HDTP with two fingers and tap with another finger.

Alternate assignments of various postures and gestures to such "Global" or "Universal" commands may be used as is clear to one skilled in the art.

Magnification Control

As another exemplary embodiment, a magnifying tool in text or design documents, a user can select an area to be magnified by setting horizontal and vertical area by dragging two finger diagonally across, pitch both fingers forward to view the magnified view of the selected area, and release the fingers to return to normal view. Other metaphors, such as finger spread, may also be used.

3D-Polyhedral Menus and Pallets

The natural 3D and 6D metaphors afforded by the HDTP system provide a very natural match for the “3D-Cube” style menus, file browsers, and desktops that are appearing in contemporary and progressive operating systems. For example, one or more of roll, pitch, and yaw angles may be used to rotate 3-D objects such as cubes and other polyhedron (tetrahedrons, cubes, octahedrons, dodecahedrons, etc.). The invention provides for polyhedra surfaces to be used for menus, browsers, desktops, pallets, and other spatial-metaphor object display and selection utilities, and for these polyhedra to be manipulated by 3D and/or 6D actions invoked from the HDTP. The invention further provides for these polyhedra to be manipulated by 3D and/or 6D metaphors natural to the HDTP such as roll, pitch, yaw and also including selection through Euclidian spatial coordinates, i.e. one or more of x, y, or downward pressure (p). The invention also provides for edges and/or surfaces of the polyhedron to be distinctively visually indexed.

Operating System Interactions

Many contemporary operating systems feature 3D desktop such as that as illustrated in FIG. 7 to enable users to switch between desktops easily. A 3D object, usually a cube, whose surfaces visually represent multiple desktops, is displayed. A 3D desktop allows a user to spin a (adjustably transparent) cube and choose any one of the displayed desktops as the currently active one. In an exemplary embodiment, a user can roll and pitch a finger to spin the cube and choose a surface among the 3D desktop surfaces. To make a selection of desktop in this example, the user can bring up 3D desktop by tapping the touchpad with two fingers and drag to the left, roll or pitch a finger to spin the 3D desktop cube in the corresponding direction, and release the finger when the desired surface is in the front. The view is then switched to normal view with the full screen of the selected desktop.

Similar to the 3D desktop feature, some operating systems displays stacked cascading windows of all open applications to enable users to switch between applications easily, such as Microsoft Windows Flip, as illustrated in FIG. 8. Such a desktop feature allows users to flip through the stack of the open windows and choose a particular application window. In an exemplary application, a user can pitch a finger to scroll through the open windows and release to choose the window that is in the front at the moment of releasing the finger. Pitching up a finger can move the cascading stack of windows in one direction, and pitching down a finger can move the cascading stack of the windows in the other direction. As an example, while a user is working on one of the open applications, the user can bring up the Windows Flip by tapping the touchpad with two fingers and drag to the right to open the Flip window and see all the open windows of applications, pitch a finger up or down to scroll through the cascading windows of open applications, and release the finger to select the desired application window.

In another exemplary embodiment, a browser window displaying thumbnail, tiles, or icons view, a user can navigate and choose a thumbnail, tile, or icon by tilting the finger left, right, up, or down to move the selection in a corresponding direction. For example, a user can open a browser window of default location or home directory (usually My Computer in Microsoft Window operating system) by tapping the touchpad with two fingers and dragging upward. As mentioned in an earlier section, rarely used gestures or gestures with more complexity are good choices for global gestures as misinterpretation of global commands can be more troublesome than that misinterpretation of context or application command. Thus, two fingers instead of one are used here, and dragging

fingers upward is used as a natural metaphor for moving up in the hierarchy. Tilting two fingers up can open a folder one step up in the hierarchy of current open folder and tilting two fingers downward can open a folder one step down in the hierarchy of current open folder. Another example is to roll two fingers to the left to go back to a folder previously visited or to roll two fingers to the right to move to the “forward” folder. FIG. 9 illustrates how the file browser browses through the history of visited folders. Elements 901-904 represent the folders visited including the current open folder 904, 911 represents the direction the browser will navigate the history when the user rolls two fingers to the left to move back to the folder previously visited, and 912 represents the direction the browser will navigate the history when the user rolls two fingers to the right to move forward in the history. For example, if the user rolls two fingers to the left to go back to a folder previously visited while the file browser is displaying contents of the folder 904, the browser will display the folder 903. Afterwards, if the user rolls two fingers to the right to go forward in the history while the browser is displaying the contents of folder 903, the file browser will display the contents of folder 904.

In another exemplary embodiment, placing the cursor anywhere on the title bar of any floating file browser window and rotating a finger clockwise can increase the size of the window. FIG. 10b illustrates an exemplary window with increased size as compared to the window illustrated by FIG. 10a. Placing the cursor anywhere on the title bar 1000 of any floating file browser window and rotating a finger counter-clockwise can decrease the size of the window. FIG. 10d illustrates an exemplary window with decreased dimensions relative to the window illustrated by FIG. 10c.

In another exemplary embodiment, placing the cursor on empty region of any window and rotating a finger clockwise can be used to increase the size of the thumbnails, tiles, or icons. Similarly, placing the cursor on empty space of any window and rotating a finger counter-clockwise can decrease the size of the thumbnails, tiles, or icons. FIG. 11a illustrates a file browser window with icons that are smaller in size relative to the icons in FIG. 11b, and FIG. 11c illustrates a file browser window with icons that are larger in size relative to the icons in FIG. 11b. Placing the cursor on any task bar items and rotating two fingers clockwise can maximize the application window, while placing the cursor on anywhere on the title bar of any application window and rotating two fingers counter-clockwise can minimize the application window. Rotating a finger clockwise and using another finger to tap can be implemented to do the same task as the right click on a mouse. For example, a user can rotate a finger clockwise to open the “right-click” menu, move a finger up or down to scroll through the items in the menu appeared once the menu appears, and tap the finger to select an item from the menu. Tilting a finger while the cursor is placed on a start menu can be used to open the start menu. When the start menu is open, the user can use a finger to scroll up or down through items on the menu and tap to execute the selected item. As another exemplary application, when a multiple tab feature becomes available in file browser windows (similar to internet browsers’ multiple tab feature) opening a new tab in the file browser can be implemented by a clockwise rotation of two fingers. Similarly, closing the current tab can be implemented by a counter-clockwise rotation of two fingers.

Internet Browser

Enhanced parameter capabilities allow faster internet browsing by enabling users for fast switching between webpages, shortcuts to open and close webpages, fast navigation of history of visited webpages, etc. Similar to multiple

11

tab file browser window, a user can rotate a finger clockwise and use another finger to tap to open a new tab **1222** for browsing. FIG. **12b** illustrates an exemplary internet browser window with an additional tap **1222** with initial tab **1221** open. While multiple tabs **1241-1245** are open, a user can rotate the finger counter-clockwise and use another finger to tap to close the tab **1245** that currently has focus in. FIG. **12d** illustrates tabs **1241-1244** remaining after the tab **1245** is closed. In FIG. **13a** and FIG. **13b**, a user can also drag a finger across a word **1301** to select the word, and roll the finger to the right and use another finger to tap to have the browser look up the definition of the word in an online dictionary website. FIG. **13b** illustrates a new tab **1311** with the page that is displaying the definition of the word **1301** user selected.

Another example is to roll the finger to the left while dragging the same finger to the left to go back to a webpage previously visited or to roll a finger to the right while dragging the same finger to the right to move to the “forward” page. FIG. **14** illustrates how the navigator browses through the history of visited webpages. **1401-1404** represent the webpages visited including the current page **1404**, **1411** represents the direction the browser will navigate history when the user rolls the finger to the left while dragging the same finger to the left to go back to a webpage previously visited, and **1412** represents the direction the browser will navigate history when the user rolls the finger to the right while dragging the same finger to the right to go forward in the history. For example, if the user rolls the finger to the left while dragging the same finger to the left to go back to a webpage previously visited while the browser is displaying the webpage **1404**, the browser will display the webpage **1403**. Afterwards, if the user rolls the finger to the right while dragging the same finger to the right to go forward in the history while the browser is displaying the webpage **1403**, the browser will display the webpage **1404**.

As another exemplary embodiment, user can shift the focus among open tabs in a browser by rotating a finger. When there are multiple open tabs in a browser, the user can rotate a finger while the cursor is placed on one of the open tabs to scroll through the tabs and select a tab to be displayed in the browser.

Navigation Applications

In geographic information systems, such as maps land by superimposition of images, there are separate controls for switching observation point such as zooming, panning, horizontal direction, or vertical direction. These controls can be combined into simple and easy motions, and having natural metaphors as control avoids conflicts among integrated applications. In an exemplary application, a user can pan or drag the map to the left or right, up, or down by dragging a finger on the touchpad in the corresponding direction. For example, when a user places a finger on the map and drag the finger to the left, the area of the map showing will be shifted to the right, so more of the right side of the map will be displayed. Also, a user may pitch a finger up or down to shift the viewpoint up or down. For example, as the user pitches the finger up, what the user sees will be as if the user was looking at the geographical image from higher up. A user can also pitch two fingers up or down to zoom in on a map or zoom out. For example, when the user pitch two fingers up to zoom in on a map, the application will show a closer view of the horizon or objects, and when the user pitch two fingers down to zoom out, the application will show a broader view. Rotating a finger clockwise or counter-clockwise can rotate the viewpoint or change the direction of the view left or right. FIGS. **17a-17c** illustrate exemplary views varying the horizontal direction of the viewpoint. Rotating a finger clockwise to

12

rotate the view point to the left will generate view as if the user turned to the right, and rotating a finger counter-clockwise to rotate the viewpoint to the right will generate view as if the user turned to the left.

These controls can be combined to control more than one thing at a time. There are several possibilities; for example, when a user is pitching a finger up as the user is rotating the finger counter-clockwise, the direction of the view will be rotated to the left as the viewpoint is raised. When the user is pitching a finger downward as the user rotates a finger clockwise, the view point is rotated to the right as the view point is being lowered. This opens vast new possibilities for controls in gaming, which will be discussed in a later section.

Web Mapping Service Applications

In web mapping service applications, similar controls can be implemented. Since most web mapping service applications are based on ground level, vertical shifting of the observation point may not be available, but all other controls can be implemented in the same manner. A user can pan or drag the map by dragging on the touchpad in the desired directions, zoom in or out of the area of the map by pitching two fingers upward or downward, or switch the direction of the view by rotating a finger clockwise or counter-clockwise.

In geographic information systems or web mapping service applications with a feature that displays panoramic surrounding photographic emersion views from a street perspective (i.e., Google Street View), similar controls can be implemented. The user can move the observation point along the streets on the map or the image of the area by dragging a finger in the direction of desired movement, and the user can switch the direction of the view by rotating a finger clockwise or counter-clockwise. For a more detailed example, when a user moves a finger upward, the application will generate views as if the user is walking forward, and when the user rotates the finger counterclockwise, the application will generate views as if the user turned to the left or to the west. FIG. **18b** illustrates an exemplary screen view of a web mapping service application with a feature that displays panoramic views along the street in a window **1811**. FIG. **18d** illustrates the screen view of initial position. FIG. **18c** illustrates an exemplary screen view of when the user rotates a finger to switch the view towards to the west, and FIG. **18e** illustrates an exemplary screen view of when the user rotates a finger clockwise to switch the view towards to the east. Also, in implementations where views along the street are only displayed at user discretion, the user can enter the Street View mode by pressing one finger down and exit from the Street View mode by pressing two fingers down.

Computer and Video Games

As games heavily rely on 3D features more and more, these additional parameters provided by the HDTP can be more useful as they can produce controls using natural metaphor. Controls that previously require complicated sequence of arrow keys and buttons can easily be implemented by combination of parameters.

Flight Simulator Game

For example, in a flight simulator game, controls that are similar to those in 3D navigation applications can be used. The user can control the direction of the movement by rolling, pitching, or rotating the finger. The user can control horizontal orientation of the aircraft by rolling the finger; roll the finger to the left to have the aircraft roll counter-clockwise and roll the finger to the right to have the aircraft roll clockwise. FIG. **20a** illustrates an exemplary view from the simulated aircraft when the aircraft is rolling to the left. The horizon **2011** appears tilted counter-clockwise relative to the horizontal orientation of the aircraft. FIG. **20b** illustrates an

13

exemplary view from the simulated aircraft when the aircraft is not rolling. The horizon **2021** appears leveled with the horizontal orientation of the aircraft. FIG. **20c** illustrates an exemplary view from the simulated aircraft when the aircraft is rolling to the right. The horizon **2031** appears tilted clockwise relative to the horizontal orientation of the aircraft. The user can control vertical orientation (or pitch) of the aircraft by pitching the finger; pitch the finger up to pitch the aircraft upward and pitch the finger down to have the aircraft downward. In a more detailed example, the simulated aircraft can take off as the user pitches a finger downward to have the aircraft pitch upward. FIG. **19b** illustrates an exemplary screen view of the initial position of an aircraft, and FIG. **19a** illustrates an exemplary view from the simulated aircraft while headed upwards and taking off. The player can land the aircraft by pitching a finger upward to have the simulated aircraft is headed down to the ground. FIG. **19c** illustrates an exemplary screen view as the simulated aircraft approaches the ground. As the simulated aircraft is headed up, the player can view more of objects that are farther away from the aircraft, and as the aircraft is headed down, the player can view more of objects that are closer to the aircraft. The user can control two-dimensional orientation of the simulated aircraft at a fixed elevation by rotating the finger; rotate the finger left to have the aircraft head to the west (or to the left) and rotate the finger right to have the aircraft head to the east (or to the right). Exemplary views from the aircraft with varied horizontal rotation will be similar to the views illustrated in FIG. **17a-c**. The player can also combine gestures for simultaneous multiple controls. For example the user can pitch a finger upward while rolling the finger to the left or right to control the aircraft roll to the left as the aircraft is headed down. As another example, the user can rotate a finger counter-clockwise as the aircraft is headed up to make the aircraft change its direction to the west while the elevation of the aircraft is rising.

Other Moving Vehicle Games

As another example, similar controls can be implemented in any racing games of car, motorcycle, spacecraft, or other moving objects. Pitching the finger downward can be implemented to accelerate the car; pitching the finger upward can be implemented to brake with adjusted amount of pressure; rotating the finger counterclockwise can be implemented to turn the steering wheel to the left; rotating the finger clockwise can be implemented to turn the steering wheel to the right. As the user rotates the finger counter-clockwise to turn the vehicle to the left and tilt the finger to the left, the car can drift.

Winter Sport Games

In skiing, snowboarding, or any first-person snow sports games, the user can rotate the finger clockwise or counterclockwise to switch the direction; the user can roll the finger left or right to switch the center of weight of the body left or right; the user can pitch the finger forward or backward to switch the center of weight of the body to accelerate or slow down; When the skier or snowboarder hits a slight uphill or mogul, the player can jump while controlling the intensity of the jump by combination of speed and the degree of pitching the finger backward.

Summer Sport Games

In sports games where the players hit balls, such as baseball, tennis, golf, or soccer, not only the player can control the direction of hitting, the player can also control the intensity of the hits at the same time by combining rotation and pitching of the finger.

Shooter Games

14

In first-person shooter video games, the direction of player's motion can be controlled by rotating a finger, the speed of running can be controlled by applying more or less pressure to the finger. FIG. **21a** illustrates an exemplary screen view of a first-person shooter game. In addition, weapon selection window can be opened by pitching two fingers forward, and once the window is open, the player can roll the finger to scroll through the selection of weapons and release the finger to select the highlighted weapon and close the weapon selection window. FIG. **21b** illustrates an exemplary screen view of a weapon selection window of a first-person shooter game. Both FIG. **21a** and FIG. **21b** have been obtained from video games that are available on the web for free downloading.

Music Performance Experience Games

In video games where players play instruments, heave and pitch of fingers can control how hard a string of an instrument is strummed or plucked or intensity of sound generated.

Media Players

In a media player, such as Winamp, Real, or Windows Media Player, increasing or reducing the volume can be implemented by pitching a finger upward or downward on the "frame." Pitching the finger on the playlist window, a user can scroll through the tracks and select the desired track to be played. In an embodiment, a media player that features polyhedron menu of multiple play lists can be controlled similar to 3D desktop. A user can tap on the play list cube and rotate the finger left, right, up, or down to select a surface among the surfaces that represents different play lists. Rewinding or fast-forwarding can be implemented by rolling a finger left or right on the timeline, and the current track may be skipped by clockwise finger rotation and the current track may be returned to the beginning by counter-clockwise finger rotation.

Spreadsheets

Similar to selecting a thumbnail, tile, or icon in an explorer window in an embodiment, a user can scroll through cells on a spreadsheet by tilting the finger left, right, up, or down. A user also can tap on a cell in an initial position, drag the finger down to set vertical range of cells and drag the finger to the right to set horizontal range of selected cells. Then the user can tilt both fingers left, right, up, or down to move the group of selected cells. Selection of cells can be done via different motions. For example, rolling the fingers left or right can select a group of multiple columns incrementally, and pitching the fingers up or down can select multiple rows incrementally.

Graphic Design Applications

As computer aided design/drafting tools features numerous features, they provide several menu items and options at different levels. Even in simply rotating an object or figures, there are many operations or steps involved. In an exemplary embodiment, instead of moving the cursor to the menu bar, clicking the drop-down menu to be opened, and moving the mouse and clicking to select the desired function, a user can use combined motion of rolling, pitching, rotating a finger that are easy to remember. For example, in some design applications such as Adobe FrameMaker™, in order for a user to draw a line, a user would have to select the line tool and click on the initial and the final point with a mouse every time. As an exemplary application of this invention, the user can drag a finger on the touchpad while applying pressure on the finger to draw a line. This way of drawing lines can be very useful when drawing curved lines as drawing lines with a finger will draw smoother lines than lines drawn by using a mouse because drawing a curved line with a finger will allow finer adjustments than drawing a curved line with a hand holding a mouse.

15

As another example, to rotate an object, the user can click on the object to select it and rotate the finger to rotate the object in the corresponding direction. FIG. 22 illustrates an exemplary use of this process in an exemplary application. This feature can be useful to correct pictures that are vertically misaligned; a user can select all of a picture and rotate the finger by desired amount of degrees. Once the picture is vertically aligned, the user can select the best fitting rectangular area of the picture to save. While an object is being rotated, the user can drag the finger around to slide the object around. Recording of such motions can be useful to generate an animation of the moving object. To group objects, the user can pitch two fingers up after the user highlights the objects by tapping on the objects while having a finger of the other hand down on the touchpad. To increase the size of a 2D or 3D object, the user can select an object and rotate two fingers counter-clockwise to decrease the size of the object or rotate two fingers clockwise to increase the size of the object. To increase the thickness of the outline of an object, the user can tap on the outline of the object and rotate two fingers clockwise. To decrease the thickness of the outline of an object, the user can tap on the outline of the object and rotate two fingers clockwise. Similar implementation can be done in word processing applications to increase or decrease the font size. As another exemplary application, to flip an object left or right, the user can click on the object to have it highlighted, tilt a finger left or right, and tap with another finger to have the object flipped left or right. Similarly, to flip an object towards a reflection point, the user can click on the object to have it highlighted, touch the point of reflection with a finger of the other hand, and tilt the finger on the object towards the reflection point.

Mobile Devices

As more functionality is added as features of mobile devices, menus and controls for these devices become complicated. Combined motion control becomes extremely useful in mobile devices whose screen size is limited. Numbers of possible shortcuts increase dramatically by using combination of motions as shortcuts. As an example of application in a mobile phone, a shortcut to "phone" or "calls" mode can be implemented by counter-clockwise rotation of a finger, and a shortcut to applications mode can be implemented by clockwise rotation of a finger on the screen. For mobile devices without detection of vertical or horizontal orientation, detection method can be replaced by having the user rotate a finger on the screen. When the user wants to view pictures sideways on the phone, the user can switch between portrait and landscape mode by rotating a finger on the screen.

As another example, while the phone is being used as music or video player, the user can pitch a finger on the screen forward or backward to control the volume, roll the finger left or right to rewind or fast-forward, or roll the finger left or right while dragging the finger in the same direction to seek to the beginning of the current track or to the next track. When the mobile device is in virtual network computing mode or being used as a remote control, all of the functions described so far can be implemented on the mobile devices.

Combinations of motions can also be used as identification on mobile devices. For example, instead of methods such as entering a security code, a device can be programmed to recognize a series of motions as identification. The identification process can allow users different level of access, for example, calls only mode, child-proof mode, or application only mode. When the mobile phone receives a phone call while it is in application mode, a user can make a global gesture to exit the application mode or the touchpad of the phone can be partitioned into sections so one section can

16

control the ongoing application and the other section can control phone functionality. In general, a touchpad user interface can be divided to have each partition control different applications.

In all of the exemplary applications described, the invention provides for any of the cited example postures and gestures to be interchanged with others as may be advantageous in an implementation.

I claim:

1. A method for controlling an operating system of a computing device, the method comprising:
 - configuring a user interface touchpad to be responsive to at least one angle of contact with at least one finger, the finger belonging to a human user of a computing device and the user interface touchpad in communication with an operating system of the computing device;
 - measuring at least one change in one angle of the position of the finger with respect to the surface of the touchpad and producing measured data;
 - performing real-time calculations on the measured data to produce a measured-angle value; and
 - using the measured-angle value to control the value of at least one user interface parameter of the operating system;
- wherein at least one aspect of the operation of the operating system changes responsive to the angle of the position of the finger with respect to the surface of the touchpad.
2. The method of claim 1, wherein the at least one finger angle comprises the pitch of the finger with respect to the touchpad.
3. The method of claim 1, wherein the at least one finger angle comprises the roll of the finger with respect to the touchpad.
4. The method of claim 1, wherein the at least one finger angle comprises the yaw of the finger with respect to the touchpad.
5. The method of claim 1, wherein the user interface touchpad is configured to be responsive to contact with at least two fingers of the human user.
6. The method of claim 5, wherein the user interface touchpad is configured to be responsive to at least tapping by at least two fingers of the human user.
7. The method of claim 5, wherein the user interface touchpad is configured to be responsive to at least dragging by at least two fingers of the human user.
8. The method of claim 5, wherein the user interface touchpad is configured to be responsive to at least one angle of contact with at least two fingers of the human user.
9. The method of claim 8, wherein the at least one finger angle comprises tilting the finger up or down with respect to the touchpad.
10. The method of claim 8, wherein the at least one finger angle comprises the roll of the finger with respect to the touchpad.
11. A method for controlling an operating system of computing device, the method comprising:
 - configuring a user interface touchpad to be responsive to at least one angle of contact with at least one finger, the finger belonging to a human user of a computing device and the user interface touchpad in communication with an operating system of the computing device;
 - measuring at least one change in at least one angle of the position of the finger with respect to the surface of the touchpad to produce measured data;
 - performing real-time calculations on the measured data to produce a measured-angle value; and

17

using the measured-angle value to control the value of at least one user interface parameter of the operating system;

wherein at least one aspect of a displayed user interface to the operating system changes responsive to the angle of the position of the finger with respect to the surface of the touchpad.

12. The method of claim 11, wherein the at least one aspect of the displayed user interface comprises a graphically rendered 3D rotation of a graphically rendered 3D desktop, the 3D desktop comprising a plurality of individual traditional computer desktop surfaces.

13. The method of claim 12, wherein a specific individual computer desktop is selected from the plurality of individual traditional computer desktop surfaces by first using the finger angle to rotate the graphically rendered 3D desktop so that desired specific desktop surface is displayed frontmost, and then releasing the finger from contact with the user interface touchpad.

14. The method of claim 12 wherein the graphically rendered 3D desktop is distinctively visually indexed.

15. The method of claim 11, wherein the at least one finger angle comprises the pitch of the finger with respect to the touchpad.

18

16. The method of claim 11, wherein the at least one finger angle comprises the roll of the finger with respect to the touchpad.

17. The method of claim 11, wherein the at least one aspect of the displayed user interface comprises a graphically rendered cascade of a plurality of individual graphically rendered application windows.

18. The method of claim 17, wherein a specific individual application window is selected from the cascade of a plurality of individual graphically rendered application windows by first using the finger angle to scroll through the graphically rendered cascade of a plurality of individual graphically rendered application windows so that desired specific individual application window is displayed frontmost, and then releasing the finger from contact with the user interface touchpad.

19. The method of claim 18, wherein the at least one finger angle comprises the pitch of the finger with respect to the touchpad, and wherein increasing the pitch angle scrolls through the graphically rendered cascade in a first direction and decreasing the pitch angle scrolls through the graphically rendered cascade in the opposite direction to the first direction.

20. The method of claim 11, wherein the user interface touchpad is operated as a touchscreen.

* * * * *